



MÂTS - BÔMES - ACCASTILLAGE
MASTS - BOOMS - HARDWARE

SPARCRAFT - FRANCE

Rue Blaise Pascal Z.I. de Périgny
F-17185 Périgny
TEL : +33 (0)5 46 45 90 45
FAX : +33 (0)5 46 45 36 59
e-mail : contact@sparcraft.com

SPARCRAFT ATLANTIQUE

Bâtiment Defvan Z.A. du Landy
F-56450 THEIX
TEL : +33 (0)2 97 43 69 29
FAX : +33 (0)2 97 43 69 03
plegoff@sparcraft.com

SPARCRAFT - USA

3901 Pine Grove Circle
CHARLOTTE NC 28206 USA
TEL : +01 (704) 597 15 02
FAX : +01 (704) 597 09 61
e-mail : info@charlestonspar.com
www.charlestonspar.com

SPARCRAFT MÉDITERRANÉE

338 ZI du Capitou F-83600 FREJUS
TEL : +33 (0)4 94 19 15 16
FAX : +33 (0)4 94 19 15 17
jpbreton@sparcraft.com



GRÉEMENT COURANT & DORMANT
STANDING & RUNNING RIGGING

SPARCRAFT RIGGING

Rue Blaise Pascal Z.I. de Périgny
F-17185 Périgny
TEL : +33 (0)5 46 34 31 27
FAX : +33 (0)5 46 34 22 60
e-mail : info@sparcraft-rigging.com
www.sparcraft-rigging.com



SYSTÈMES D'ENROULEMENT
FURLING SYSTEMS

FACNOR (FURLING DIVISION)

BP 222 Parc d'activité
F-50550 St Vaast-la-Hougue
TEL : +33 (0)2 33 88 50 22
FAX : +33 (0)2 33 23 14 27
e-mail : info@facnor.com
www.facnor.com



SPARCRAFT™
Performance Engineering

ASSEMBLY MANUAL Advice and procedures



NOTICE de MONTAGE Conseils & procédure



Prix / Price : 10 euros

Non-binding document - Design and photo credits: E.B. / Groupe Losange - Sparcraft - 2008 - Merci à AD Cherbourg - Special thanks to Eurospar and Sailspar.



A WORLDWIDE NETWORK



Stepping a mast is an involved and precise operation. We therefore advise you hire the professional services of a rigger. Please visit our website to see the list of Sparcraft agents. SPARCRAFT reserve the right to modify without notice all or part of these instructions.

 Version française page 26

w w w . s p a r c r a f t . c o m

Thank you for the interest you have shown in the Sparcraft brand. This document offers some advice to ensure that the mast and rigging installation goes well. So that you can follow the recommended procedure it gives a step by step account from unpacking the mast to its first use. This advice is a guide only and is not intended to replace the services of a professional.

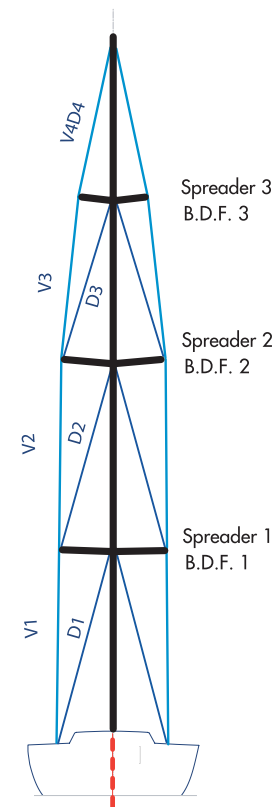

FIG. 1 - planted mast
(fitted to the keel)

In short, there are several types of rig:

- masthead rig: The forestay is attached to the top of the mast;
- fractional rig: the forestay is attached below the top of the mast (9/10 or 7/8 of the way up the mast for example);
- with one or two sets of spreaders, which may be swept-back (fig.2) or in-line ("in the axis");
- continuous (guided shrouds, the opposite which are not fixed to the tip of the spreaders) or on the contrary, discontinuous (section 5.3 and 5.4);
- the mast may be fitted to the deck or keel stepped (fig1).

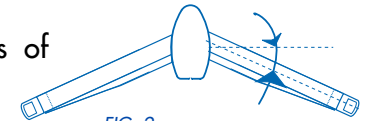

FIG. 2
Swept-back spreaders:
angling of spreaders in relation
to the axis of the mast

These various types of rig require different installations and adjustments (see sections 5.3 and 13). We have dedicated section 12 to catamaran rigs.

N.B. For furling masts please consult the relevant instructions

REMINDER AND CHECKS DURING THE PROCEDURE: see the end of this document



Inventory

Depending on where it is being delivered, the mast is packed in various materials: plastic, padding, wooden battens.

- carefully unpack the mast and check the overall condition in order to identify any problems;
- the condition of the packaging can be a determining factor in this checking process;
- before being sent, all our masts are inspected by our experts. The rare problems that are found tend to occur during transportation, which is why it is important to carry out a check on delivery;
- sort out and count all the necessary parts;
- when unpacking, avoid cutting the messenger lines and scratching the mast. Please be careful when using a cutter, knife or other sharp instrument.

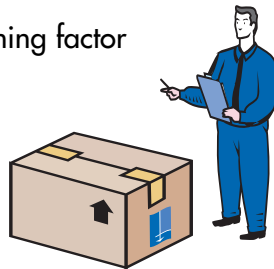

Please be careful to avoid scratching the mast



REMINDER

- Sparcraft masts are delivered with running rigging (or the halyard messenger lines) attached and stuck to the mast;
- spars and standing rigging are kept separate in order to minimise the risk of damage during transportation.



Traceability: number check.

For Sparcraft, each rig is unique, which is why we give it an identification number enabling you to know where it has come from and which route it has taken. This is a way for us to guarantee the quality. Please note down these numbers in this booklet.



- MAST (engraved near where the sail joins) N° _____
- BOOM (near the gooseneck) N° _____
- STANDING (on the bottom tip of the backstay) N° _____

PREPARATION OF THE MAST AND EQUIPMENT

Preparation of the tools necessary for the operation

- identify each element of the mast and standing rigging;
- prepare the tools required for stepping the mast and the adjustments;
- use the right equipment: this avoids damaging the equipment (mallet instead of a hammer, for example).



Setting up and protecting the mast

- set the mast down on Trestles, which have been protected by foam or other soft material.

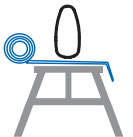

The **centre of gravity of the mast** (where it is balanced to work on) is defined by a red mark on the mast packing. Indicate this mark (after unpacking) with a strip of red tape.

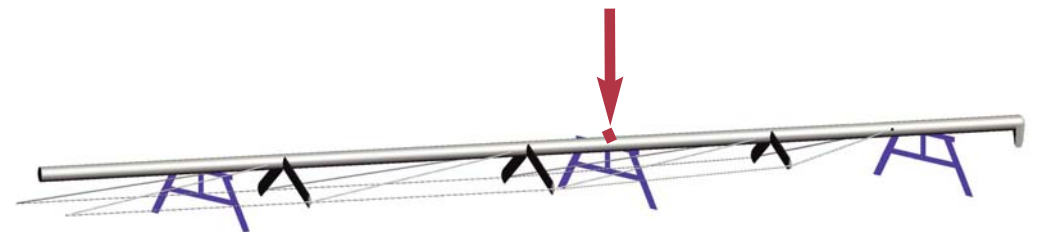



Take particular care when drilling not to damage anything

Drilling holes and pre-assembly

We are talking here of a pre-assembly, not a final assembly

- without fixing - of the aerals and lights:
- pass the cables through using the messenger lines;
- carry out the drilling, put in position the brackets;
- carry out the pre-assembly of the mast head equipment and deck lighting, taking care not to damage the sheaves;
- run through the cables that are required (additional lights and VHF) or planned for the future;
- Fill in around the holes to make them watertight;
- position the VHF aerial upside down (risk when being lifted);
- check the holes at the foot of the mast.

Passing through the messenger lines

You can leave one or more messenger lines in case of any future connections.



Front side - fore halyards / Rear side - rear halyards

Run the halyards through using the messenger lines (not for the pre-assembled halyards). Position the mast:

- front side downwards for the fore halyards;
- rear side downwards for the rear halyards;
- check that all of the halyards are clear, (not caught anywhere), are parallel to the exit holes from the mast and are free to move (exit from sheaves);
- make a knot to hold each halyard in place ("figure of eight knot").

The standing rigging ("side rigging") is fitted by starting at the top of the mast and gradually feeding it down step by step to the foot. The diagonal rigging (intermediate shrouds) and the spreaders are fitted during this process.

The standing rigging will be placed on either side of the mast.

Fitting of shells

The shells are placed into the mast (before the cables are threaded through the holes in the spreaders) in three simple stages:

Fitting



Rotation



Positioning



fixing a safety rivet

An aluminium rivet is placed into the top hole to stop the shell falling out during the stepping of the mast. Ensure the shell is in place before inserting the rivet. This rivet does not serve any structural purpose, as once the mast is erected, the shells are kept firmly in place by the rigging tension.

Types of masthead rig

- Side shells: come ready fitted (with rivet attachment);
- T-terminal: Line up the terminal at 90° and turn it 90° to fit into its housing. Fix a stopper in place to prevent it falling out (particularly for the runners);
- External masthead rig (on tangs): never apply tension to the bolts that pass through (risk of squashing the mast). Secure the attachment making sure to open up the split pin once the swage eyes are in place.

5.2

Fitting of spreaders

- the spreaders must be carefully positioned and fixed at each panel of the mast. The use of a mallet is recommended to avoid scratching the aluminium;
- place the spreaders top side up;
- open the pins very slightly (to ensure the spreaders are firmly fixed in place and that there is no movement in the spreaders).



Split pin to be opened to 90°



or use split rings

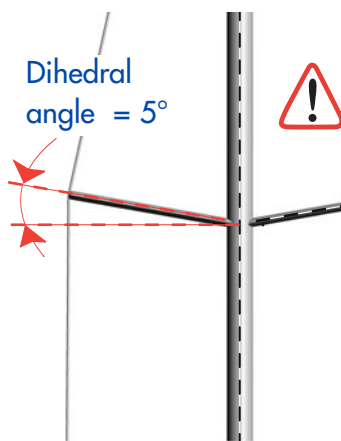

Please note: it is possible to use a clamp to fit the spreaders on steel bars: follow the instructions included with these spreaders.

Spreader tip fittings

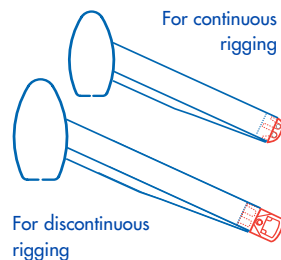

Attach the tip fittings to the ends of the spreaders (continuous and/or discontinuous), so they can receive the top and intermediate shrouds.

Special precautions with discontinuous rigging

If using discontinuous rigging, each cable must be aligned and placed so that all the parts are correctly positioned:

- Clevis pin on top, the corresponding eye on the bottom;
- release the turnbuckles on the diagonal rigging (See figure for order V / D).

These should be loosened all the way.



Release the tension on the diagonal rigging as much as possible

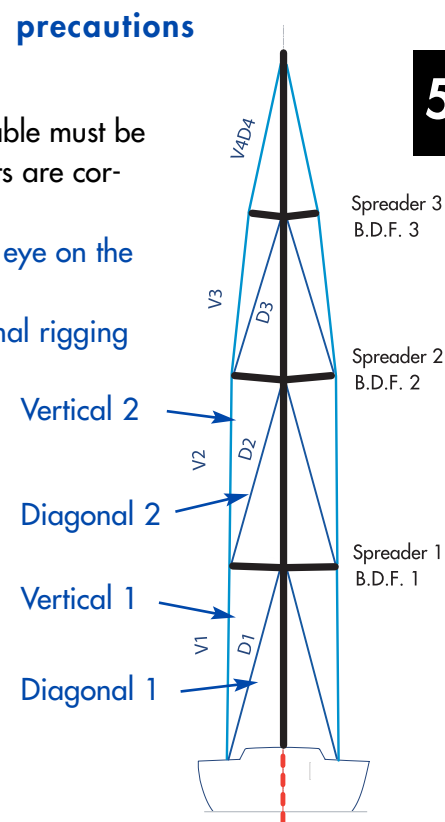
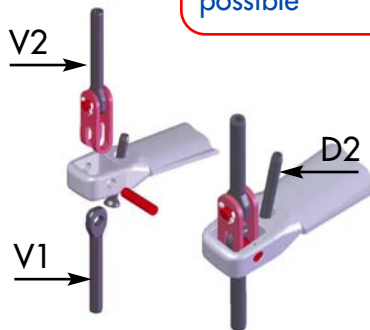

5.3

Pay particular attention to the fitting of the jumper. Angle of jumpers V2D3 and dihedral angle of 5° upwards (see figure page 6)

Checks and preparation of the turnbuckles

- unscrew the turnbuckles (pin removed) by turning the body clockwise;
- the turnbuckles are designed with right and left hand threads. Position the body with the **right screw on the bottom** (traditional screw direction);
- Think ahead: with the mast stepped, nothing must stop the turnbuckles from being tightened quickly (shrouds and forestay) to keep the shape;
- keep the turnbuckles **clean**. Lubricate if required with Sparcraft Rigging grease;
- **protect the turnbuckles** (cloths and/or tape) to avoid knocks during handling.

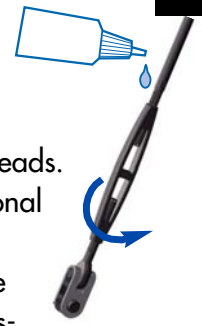

Final check

- check each pin is in place;
- tie the standing and running rigging to the mast (forestay slack);
- check that the turnbuckles and pins are compatible with the deck fittings and chain plate;
- Mast fitted to the keel: measure the distance under the deck and compare with the distance between the foot and deck stop.

Protect any parts that jut out

- It is recommended that all sensitive elements of your rig be protected. A simple piece of rigging tape can be placed on clevis and split pins. This will help prevent unnecessary wear to sails. This mark can also be used as an indicator during checks on all the fittings.
- attach the foam protection to the front side of the spreaders to avoid contact with the furler when moving the mast.



Special precautions with continuous rigging

- check the cable housing (front or rear) is correctly positioned before screwing the spreader tip fittings in place: the way the top and intermediate shrouds pass through the tips of the spreaders is determined by the position order of the cables on the chain plate on the boat (in general the lower holes on the chain plate are for the intermediate shrouds);
- Otherwise, the default arrangement is: cap shrouds on the back and intermediate shrouds on the front.

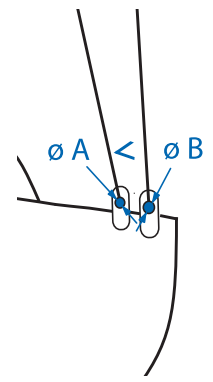

Check the positioning of the cables before fixing the tips of the spreaders

Line up the side rigging alongside the mast

- continuous rigging: side by side while carefully protecting the mast and the turnbuckles (see below);
- discontinuous rigging: tighten V1 by attaching a rope between the boom vang attachment and each turnbuckle and stretch D1 out along the mast

Fit the backstay and runners

- backstay: check the direction of the pin (pin towards the mast); It is advisable to protect this with sticky tape;
- runners: pins towards the mast.

Fit the forestay

- Staysail stay (if applicable): attach it to the length of the mast;
- forestay and furler: Lay the furler on the ground on padding to protect it (do not store the furler on the mast) and fit it at the end.



Masthead equipment

- Fitting of equipment (navigation lights,...) on land: complete this installation at the end. Cut down the amount of times you have to climb the mast and make sure they fit before stepping;
- Fitting from the top: prepare the fragile elements (aerials and/or wind indicators), but do not fix them until the mast is stepped and checked (temporary fitting of aerial upside down before lifting). Please consult the instructions from the manufacturers of such equipment and the recommendations from the crane-driver during the lifting process.



Checking the cables and connections

- any electric shock can cause corrosion. Please check the condition of the cables and the bulbs in the navigation lights. Have them tested if necessary;
- Check the electrical connections and protect them with an appropriate product.

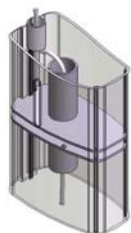
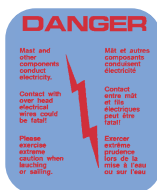

Final visual check

Planted mast should read keel stepped mast : check the position of the watertight system inside the mast (generally found at the lowest halyard exit). You should only see daylight through the central tube for the electric cables. No light should pass through the main section



Precautions during hoisting

The operation needs to be carefully planned due to the high risks involved, concerning the equipment and the safety of those taking part in the operation.

- Avoid lifting in strong winds;
- stabilise the boat.
- At each stage, all of the cables are together and the running and standing rigging are attached to the foot of the mast except for the forestay (or furler) which is loose and ready to be attached.

Please note: We are giving you a tried and tested method for stepping the mast, but it is up to you to decide whether this is suitable depending on your rig configuration, the crane and the environment:

Sling

The hook must be fitted with a safety catch. Add an additional turn around the jaws of the sling.



- place the sling stop above the centre of gravity of the mast as marked by the sticky tape (balance point) and knot it tight using a bow-line;



- take the sling from its hoisting point to the bottom of the mast and fix it to the gooseneck fitting;
- pull in and bring together any surplus stop;
- tie a tow rope between the anchorage point and the boom vang attachment (or gooseneck fitting);
- Depending on the size of the mast and configuration, prepare a tow rope from the tip of the top spreader.

Safety procedures:

The lifting and attachment stops must be suitable for the load and tightly knotted. Position the mast above the deck of the yacht. Guide the mast into place with the help of the tow ropes.

Securing a deck stepped mast

- place the foot of the mast into its base;
- fix the standing rigging: forestay, babystay, cap shrouds, lower shrouds, runners, backstay just to secure the mast. Tighten the turnbuckles **simply by hand** to begin with (see below).

Fitting the furler: please read the instructions supplied by the manufacturer.

Securing a keel stepped mast

The mast must be perpendicular to the vertical of the boat.

- fit the items (wedge and flange) from the mast sleeve kit. The deck must be clear and the collar fixed with flange ready to receive the mast;
 - two people guide the mast into its collar above the deck and give instructions before crossing the deck. A third person helps with these operations and gives instructions from inside the boat.
 - pass the electric cables carefully through the deck collar;
 - lower the mast;
 - simple step: guide the mast into its housing;
 - U-shaped step: the same to fix the mast with the axis going through the simple step;
- The exact position of the axis depends on the adjustment required: the further forward the axis, the greater the rake. The neutral point is of course in the middle (see the adjustments section 12).



Neutral position in the middle of the step

N.B.: to avoid any damage to the mast as it is lowered, protect it (plastic film or padding).

- fit the forestay to its attachment;
 - fit the lower shrouds, then the main shrouds. Hand tighten the turnbuckles (Do not use a spanner) to obtain a balance (bd/td);
 - fit the backstay(s);
- N.B.: on some models, the backstay is calculated precisely to ensure the correct tension when under strain.
- If it is difficult to fit: ensure that the mast is not leaning forward, release the stay completely (turnbuckles or link plates), release D1 (lower shrouds), tighten slightly V1 (cap shrouds) and using the mainsail halyard fixed to a solid point (cleat, traveller track), swing the mast backwards to allow the backstay(s) to be attached.
- With the backstay(s) in place, tighten by hand all of the turnbuckles to secure the mast.

Free the sling

When the mast is safely in place and secured, release the sling. Remove the return knot at the foot of the mast.

Sleeve kit



- Line up the bolts in their respective places and squeeze the elastomer seal in order to ensure it is completely watertight. To be safe, ensure that the seal is uniformly tight, in order to avoid any risk of leaking. This needs to be firmly tightened. We recommend that for the aluminium system with screwed seals that the screw be protected with a special product (duralac, Teg gel...)
- have available a silicon joint or PU glue to ensure contact between the seal and mast and the sleeve in the housing. Leave to dry for 24 hours before use;



MAST FITTED TO THE KEEL

Deck tie rods

As the halyards are attached to the collar on the deck, it is essential to compensate for the load they exert upwards. It is therefore necessary to fit one or two deck tie rods, according to the size of the mast, between the collar and the stepped part of the mast.

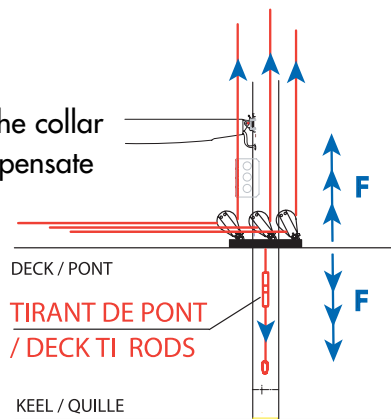

WARNING !

IF YOUR MAST IS EQUIPPED WITH THIS TYPE OF TIE ROD, DO NOT RAISE ANY HALYARDS OR TENSION THE RIGGING UNTIL DECK TIE RODS ARE ATTACHED TO THE MAST COLLAR AND THE MAST FAILURE TO DO THIS COULD RESULT IN SEVERE DAMAGE TO THE DECK STRUCTURE.

ATTENTION !

SI VOTRE MAT EST EQUIPE DE CE TYPE DE TIRANT, NE PAS ETARQUER LES DRISSES OU METTRE LE GREEMENT SOUS TENSION AVANT DE POSER LE TIRANT ENTRE LE COLLIER ET LE MAT SOUS PENNE DE PROVOCUER DE GRAVES DOMMAGES A LA STRUCTURE DU BATEAU.

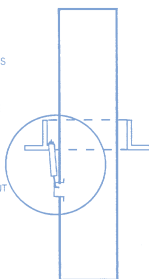

If this key part is forgotten, serious structural problems could result.

Mast jack: please see the specific instructions

HALYARD EXITS

Angling the halyard channels

- bring the running rigging to the foot of the mast to allow the layout to enter the cockpit and go on to the blocks;
- for the halyard layouts: angle the blocks to the mast exits to avoid early wear on the running rigging. The way it is spread out depends on the recommendations from the manufacturer

Angle the blocks to suit the halyard exits

and your choices of on-board organisation.

BOOM AND POLE

Installation of the boom

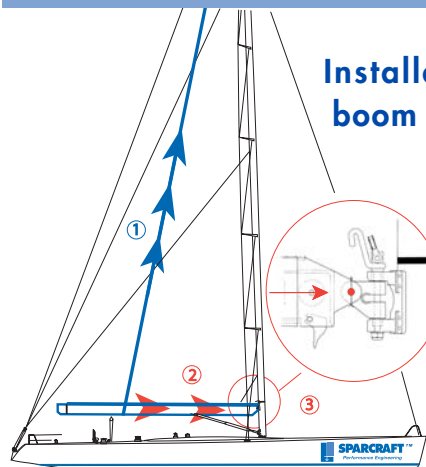

Positioning the boom on the ball joint on the gooseneck fitting:
 - manoeuvres with a short-handed crew:
 With the help of the topping lift or directly with the mainsail halyard, ease the weight on the boom;

- once raised to a comfortable position, insert the front tip of the boom into the gooseneck.

N.B.: for some models, the ball joint is fitted in a different direction (delivered upside down). Keep it this way up (Do not turn over).

- fit seals or collars on either side of the joint, according to the original assembly;
- lock in position with a pin or bolt.

Taking in a reef with continuous rigging

Reefing is carried out from the cockpit, and the fitting process is no different than that of a classic boom.

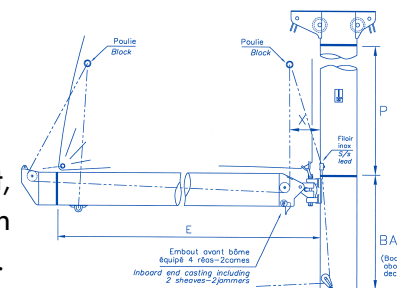

Pole

- check the mechanisms are working properly. Lubricate if necessary;
- adjust the lengths of the topping lift and boom vang. Mark adjustment points on these with the mast in place.

CATAMARANS - Special instructions

Catamarans are usually fitted with self-standing systems, which keep the mast in place with a forestay and two top stays fastened to chain plates on the hull.

These self-standing masts can be divided into two groups:

- pivoting masts called teardrop masts or wing masts (wing masts as found on Formula 28 and F 40);

- fixed masts.

These fixed masts are rigged in different ways:

- masts on tripods: the spreaders are connected to the front by a martingale and a jumper enabling the mast to be made rigid lengthways;

- intermediate shapes: the mast is simply supported sideways by the spreaders and a bigger set of shrouds (not self-standing lengthways, so no jumpers);

- chimney masts: with no front jumper nor spreaders, but the shrouds include lower shrouds and occasionally a staysail stay.



Catamaran rig
(diamond rig)

CATAMARANS - Pre-adjustment before fitting

The special characteristics of the self-standing rigs on multihulls mean that the lateral diamond shapes and jumpers are under tension and pre-adjusted before stepping the mast in order to obtain a rigid structure.

See also the special instructions.

Marks

- the mast must be placed lengthways in the boat;
- to carry out the adjustments, use the mainsail halyard in order to measure the distance to an equidistant point on either side.

Rake

- finely adjust in order to find the best "Rake/Prebend" (see below);

- the tension of the forestay and the backstay should, if possible, be the same as that of the shrouds and should induce a rake φ (angled backwards) by about 1 to 1.5°.

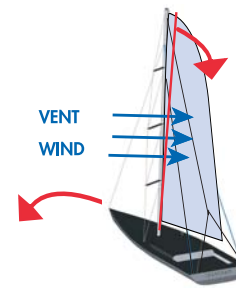

- e.g.: 10-metre mast: masthead pushed back by about 20 cm. This mast rake will determine whether the boat has a lee helm or a weather helm. The greater the rake, the more car take out weather helm and vice versa.

Adjust only for a very small amount of pre-bend on furling masts (see instructions)

$$\varphi = 1 \text{ to } 1,5^\circ$$

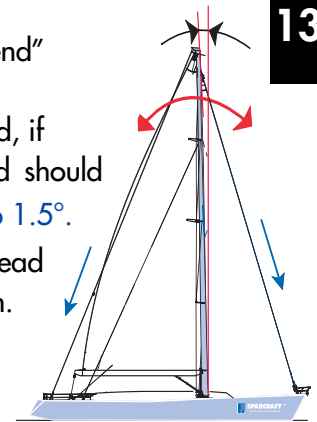

Tension of the rigging at the masthead and on the spreaders:

1. adjust the rake with the forestay, then tighten the backstay (see section 13.1);
2. centre the mast sideways using the cap shrouds and tighten them symmetrically in order to obtain an upright mast;
3. apply tension to the rear and front lower shrouds allowing a slight prebend then adjust the intermediate shrouds checking the cross-section is upright (looking along the sail track);
4. apply the final tension maintaining the same order and then carry out checks under sail. The tension on the cap shrouds and the lower rear shrouds should be high.

13.3

Tension of the head rigging with sweptback spreaders

Special instructions: swept-back spreaders support the mast from the sides and lengthways. By increasing the tension, the mast is pushed forward at the level of the spreaders creating a curve. Carry out the following step by step procedure to obtain the correct rake / pre-bend / tension:

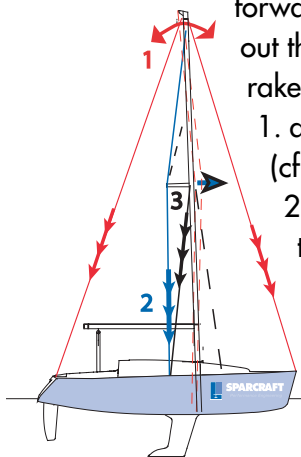

1. adjust the rake with the forestay, then tighten the backstay (cf 13.1);
2. centre the mast sideways using the shrouds and tighten them symmetrically to obtain a regular bend of the mast (20 cm for a 35');
3. apply tension to the lower shrouds, then the intermediate shrouds checking the mast is upright and with the right bend;
4. Complete the adjustment to the tension in the same order and then after sailing trials. The tension on the cap shrouds (V1) and lower shrouds (D1) must be high.

Regularly check the vertical alignment along the sail track.

Please note for discontinuous rigging: the turnbuckles on the intermediates (D2) must be completely open during the adjustment of the V1/D1, and can be closed once the tension of V1/D1 is complete. The tension on D2 must be low: close the turnbuckles by hand and two spanner turns.

13.4

Tension on the fractional rigging with swept-back spreaders

Proceed as in section 13.3, but take into account the following characteristics:

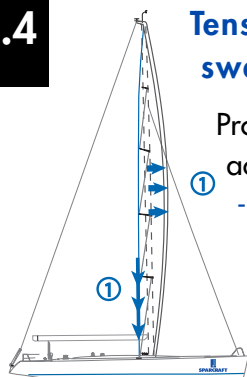

- 1 - increasing the tension on the cap shrouds pushes the mast forward creating a pre-bend;
- tightening the lower and intermediate shrouds will reduce the bend;

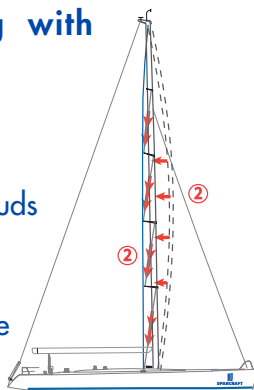

- a slight permanent bend is desirable;
- leave a pre-bend of 6 to 7 cm. The cap, intermediate and lower shrouds must then be taut;
- adjust the running backstays to finish, as they work in opposition to the rest of the rig;
- when the back angle of the spreaders is below 15°, the tension required on the running backstay is high, in order to support the mast backwards;
- If the rear angle of the spreaders is above 15°, the spreaders will also support the mast lengthways and the tension on the backstay does not need to be so high. However, be careful not to exceed the limit to avoid a mast inversion.

Tension of fractional rigging with in-line spreaders

- proceed as in section 13.3. Note:
- The rigging with in-line spreaders is adjusted as with top rigging, the only difference being the addition of backstays for the tension of the forestay;
- The mast should always be adjusted with a certain bend forwards/backwards, otherwise the curve of the mast may be inverted particularly in strong winds.

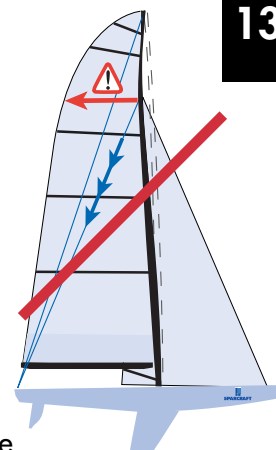

Avoid a negative bend ("curved backwards")

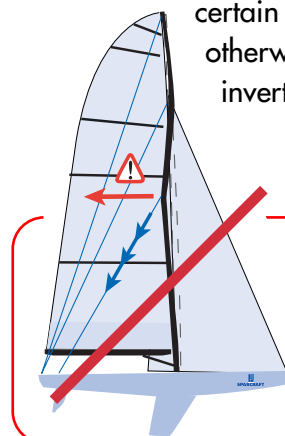

the babystays adjust the bend of the mid-section of the mast. If they are too tight in relation to the backstays, they can cause the inversion of the mast bend.

13.5

Checking adjustments under sail

- check the adjustments in moderate or light winds on calm seas. It is preferable if you can avoid having to deal with manoeuvres by taking aboard some experienced crewmen;
- check the alignment of the mast upwind looking along the sail track (**lateral alignment**) which should be straight on both tacks;
- the leeward cap shrouds should not be completely slack.

If this is the case on both sides, take in (once moored ashore) the same number of turns on each side of the mast. Redo the adjustment as many times as necessary until fine-tuned.

N.B.: a new rig requires an additional adjustment after its first sailing trips.

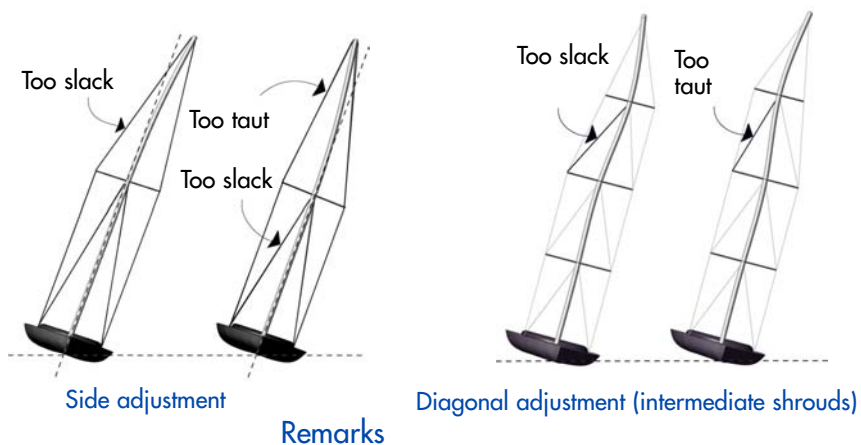

concerning discontinuous rigging:

- before applying tension to VID1, it is imperative that you ease the diagonals first.

N.B.: some classes of yacht have their own specific information concerning the tension of the rigging. Please consult these documents.



Once back in harbour

- make a mark to identify the adjustment position once back in port;
- note down all these adjustments in order to be able to re-use them whenever required after wintering;

N.B.: take into account the stretching of cables over time.

- if the turnbuckles have been adjusted at sea, please check to ensure that the pin is in place and that they are open;
- You can protect the sails by using a protector on the turnbuckles and sticky tape on the pins.

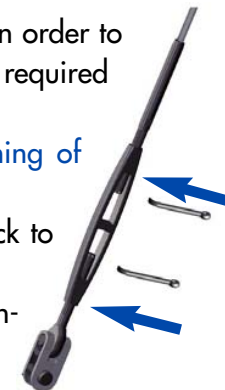

Maintenance

- Regularly check the condition of the standing rigging. Use the services of an expert to carry out a complete service check, as required;
- when preparing the yacht for winter, rinse off the aluminium parts: mast, foot of the mast, boom, boom vang, pole,...;
- also rinse off the running rigging;
- check the halyards and their sheaves;
- check the condition and movement of the reefing pennants.

For operations to be carried out at the top of the mast: make sure you have the right comfortable safety gear.



Trimming the sails

The techniques used to obtain the perfect trimming also depend on the shape of the sails and the characteristics of the boat. It is therefore important to obtain advice and consult your sailmaker.

UNPACKING AND CHECKING

P2 to P3

1

- Inventory / Reminder
- Note down the serial numbers
 - Mast N° _____
 - Boom N° _____
 - Standing rigging N° _____

PREPARATION mast and equipment

P3

2

- Preparation of the tools required
- Installation of the mast and centre of gravity

PRE-ASSEMBLY CONNECTIONS

P4

3

- Drilling and pre-assembly

RUNNING RIGGING

P4

4

- Passing the halyards through and checks

FITTING THE STANDING RIGGING

P5 to 8

5

- Insertion of shells / types of masthead gear (5.1)
- Installation of spreaders and tip fittings (5.2)
- Precautions with discontinuous rigging (5.3)
- Precautions with continuous rigging (5.4)
- Line up all the side rigging against the mast (5.5)
- Fit the runner and backstays (5.6) Fit the forestay (5.7)

PRECAUTIONS BEFORE STEPPING THE MAST

P9 to 10

6

- Checking and preparing the turnbuckles Protection
- Electrical equipment Visual check

RAISING THE MAST

P11

7

- Precautions when hoisting
- The sling Safety during the manoeuvre

P12 to P13

PUTTING THE MAST IN PLACE

- Care with the mast
- Special instructions for a mast fitted to the keel (8.1)
- Sleeve kit (8.2)

P14

MAST FITTED TO THE KEEL

- Fitting deck tie rods

P14

HALYARD EXITS

- Angling the blocks

P15

BOOM AND POLE

- Installation of the boom /taking in a reef with continuous rigging
- Pole

P16

CATAMARANS

- Special characteristics / Pre-adjustment before fitting

P17 to 19

ADJUSTMENTS, RECOMMENDATIONS

- Marks Rake (13.1)
- Tension of the masthead rigging with in-line spreaders (13.2)
- Tension of masthead rigging with sweptback spreaders (13.3)
- Tension of fractional rigging with sweptback spreaders (13.4)
- Tension of fractional rigging with in-line spreaders (13.5)

P20 to 21

ADJUSTMENTS AND SEA TRIALS

- Checking the tuning under sail
- Precautions on arrival back in harbour
- Maintenance / Trimming the sails

P22

ADJUSTMENT INDICATIONS