

# SmartPilot Series

## Commissioning Guide

Document reference: 81273-2  
Date: April 2006

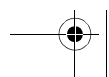

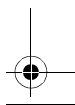
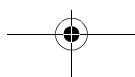
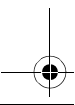
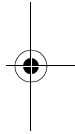
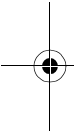

Autohelm, HSB (High Speed Bus), SailPilot, SeaTalk and SportPilot are registered trademarks of Raymarine UK Ltd.  
Raymarine, SmartPilot, AST (Advanced Steering Technology), AutoAdapt, AutoLearn, AutoRelease, AutoSeastate, AutoTack,  
AutoTrim, FastTrim, GyroPlus, RayGyro, RayPilot and WindTrim are trademarks of Raymarine UK Ltd

Copyright © Raymarine UK Ltd

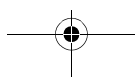

# Important Information

## About the documentation provided

Welcome to Raymarine SmartPilot. The autopilot system that will steer your boat to a heading automatically, accurately, reliably and comfortably.

SmartPilot documentation is arranged so that you can install, commission and quickly use your SmartPilot, keeping to hand only the information necessary.

- **Installation Sheets** - One per element of the system, these easy to understand sheets guide you through the installation process. These can be discarded once the installation is complete.
- **SmartPilot Commissioning Guide** - This book. Describes how to connect, commission and configure the system.
- **Quick Start Guide** - Once commissioned, use your Smart Pilot right away with this handy guide to the main operations.
- **SmartPilot Operating Guide** - Detailed operating information about your SmartPilot.

**Note:** *This handbook contains important information about the installation and commissioning of your new Raymarine product. At the back there is an index and glossary of terms. To get the best from the product please read this handbook thoroughly.*

## SmartPilot Controller Compatibility

This handbook allows you to commission your SmartPilot with any of the available SmartPilot controllers. The control method for each controller is detailed below.

ST6001 & ST6002 Controller	ST7001 & ST7002 Controller	ST8001 & ST8002 Controller
<ul style="list-style-type: none"> <li>• <b>standby &amp; auto</b> function keys</li> <li>• <b>+1, -1, +10 &amp; -10</b> course change keys</li> <li>• <b>disp &amp; track</b> extended function keys</li> </ul>	<ul style="list-style-type: none"> <li>• <b>standby &amp; auto</b> function keys</li> <li>• <b>+1, -1, +10 &amp; -10</b> course change keys</li> <li>• <b>resp, track, mode, res'm, disp, up &amp; down</b> extended function keys</li> </ul>	<ul style="list-style-type: none"> <li>• <b>standby &amp; auto</b> function keys</li> <li>• <b>Rotary</b> course change control</li> <li>• <b>resp, track, mode, res'm, disp, up &amp; down</b> extended function keys</li> </ul>

## Safety notices



### **WARNING: Product installation**

**This equipment must be installed and operated in accordance with the instructions contained in this handbook. Failure to do so could result in poor product performance, personal injury and/or damage to your boat.**

### **CAUTION:**

**Before installing the SmartPilot computer and drive unit, check that they are the correct voltage for your boat's supply.**

As correct performance of the boat's steering is critical for safety, we **STRONGLY RECOMMEND** that an Authorized Raymarine Service Representative fits this product. You will only receive full warranty benefits if you can show that an Authorized Raymarine Service Representative has installed or commissioned this product.



### **WARNING: Electrical safety**

**Make sure the power supply is switched off before you make any electrical connections.**



### **WARNING: Calibration requirement**

**We supply this product calibrated to default settings that should provide initial stable performance for most boats. To ensure optimum performance on your boat, you must complete *Chapter 2*.**



### **WARNING: Navigation aid**

**Although we have designed this product to be accurate and reliable, many factors can affect its performance. As a result, it should only be used as an aid to navigation and should never replace common sense and navigational judgement. Always maintain a permanent watch so you can respond to situations as they develop.**

Your SmartPilot will add a new dimension to your boating enjoyment. However, it is the skipper's responsibility to ensure the safety of the boat at all times by following these basic rules:

- Ensure that someone is present at the helm **AT ALL TIMES**, to take manual control in an emergency.
- Make sure that all members of crew know how to disengage the autopilot.
- Regularly check for other boats and any obstacles to navigation – no matter how clear the sea may appear, a dangerous situation can develop rapidly.



- Maintain an accurate record of the boat's position by using either a navigation aid or visual bearings.
- Maintain a continuous plot of your boat's position on a current chart. Ensure that the locked autopilot heading will steer the boat clear of all obstacles. Make proper allowance for tidal set – the autopilot cannot.
- Even when your autopilot is locked onto the desired track using a navigation aid, always maintain a log and make regular positional plots. Navigation signals can produce significant errors under some circumstances and the autopilot will not be able to detect these errors.

## EMC Guidelines

All Raymarine equipment and accessories are designed to the best industry standards for use in the recreational marine environment. Their design and manufacture conforms to the appropriate Electromagnetic Compatibility (EMC) standards, but correct installation is required to ensure that performance is not compromised.

Although every effort has been taken to ensure that they will perform under all conditions, it is important to understand what factors could affect the operation of the product.

The guidelines given here describe the conditions for optimum EMC performance, but it is recognized that it may not be possible to meet all of these conditions in all situations. To ensure the best possible conditions for EMC performance within the constraints imposed by any location, always ensure the maximum separation possible between different items of electrical equipment.

For optimum EMC performance, it is recommended that wherever possible:

- Raymarine equipment and cables connected to it are:
  - At least 3 ft (1 m) from any equipment transmitting or cables carrying radio signals e.g. VHF radios, cables and antennas. In the case of SSB radios, the distance should be increased to 7 ft (2 m).
  - More than 7 ft (2 m) from the path of a radar beam. A radar beam can normally be assumed to spread 20 degrees above and below the radiating element.
- The equipment is supplied from a separate battery from that used for engine start. Voltage drops below 10 V, and starter motor transients, can cause the equipment to reset. This will not damage the equipment, but may cause the loss of some information and may change the operating mode.

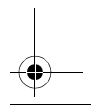
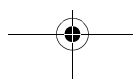
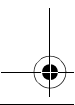
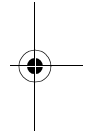
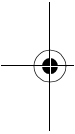

- Raymarine specified cables are used. Cutting and rejoining these cables can compromise EMC performance and must be avoided unless doing so is detailed in the installation manual.
- If a suppression ferrite is attached to a cable, this ferrite should not be removed. If the ferrite needs to be removed during installation it must be reassembled in the same position.

### EMC suppression ferrites

The following illustration shows typical cable suppression ferrites used with Raymarine equipment. Always use the ferrites supplied by Raymarine.

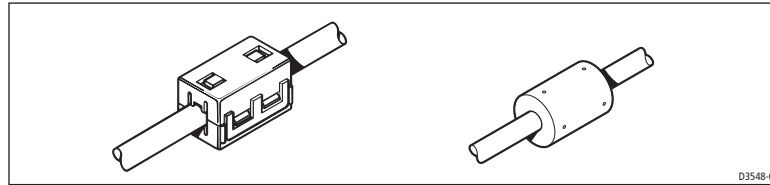

### Connections to other equipment

If your Raymarine equipment is to be connected to other equipment using a cable not supplied by Raymarine, a suppression ferrite **MUST** always be attached to the cable near to the Raymarine unit.

### Waste from Electrical and Electronic Equipment (WEEE) Directive



The Waste from Electrical and Electronic Equipment (WEEE) Directive requires the recycling of waste electrical and electronic equipment. Whilst the WEEE Directive does not apply to some of Raymarine's products, we support its policy and ask you to be aware of how to dispose of this product.

The crossed out wheeled bin symbol, illustrated above, and found on our products signifies that this product should not be disposed of in general waste or landfill.

Please contact your local dealer, national distributor or Raymarine Technical Services for information on product disposal.

### Handbook information

To the best of our knowledge, the information in this handbook was correct when it went to press. However, Raymarine cannot accept liability for any inaccuracies or omissions it may contain. In addition, our policy of continuous product improvement may change specifications without notice. As a result, Raymarine cannot accept liability for any differences between the product and the handbook.

## Contents

<b>Important Information</b> .....	i
About the documentation provided .....	i
<b>WARNING: Product installation</b> .....	ii
<b>WARNING: Electrical safety</b> .....	ii
<b>WARNING: Calibration requirement</b> .....	ii
<b>WARNING: Navigation aid</b> .....	ii
EMC Guidelines .....	iii
EMC suppression ferrites .....	iv
Connections to other equipment.....	iv
Handbook information .....	iv
<b>Contents</b> .....	v
<b>Chapter 1: System Connections</b> .....	1
1.1 Before you start .....	1
1.2 The SmartPilot computer .....	2
SmartPilot types.....	2
1.3 Removing and replacing the connector cover .....	3
<b>WARNING: Electrical safety</b> .....	3
Computer inputs, outputs and fuses .....	4
1.4 Connecting the Power and the Drive unit .....	5
Grounding the SmartPilot .....	7
1.5 Fuse Protection .....	8
1.6 How to connect SmartPilot system elements .....	8
Securing the Cables.....	9
1.7 How to connect SeaTalk equipment .....	9
Single control unit, single power supply .....	9
Isolated control unit, single power supply (S2 and S3 computers only) .	10
Separate SmartPilot computer and instrument power .....	10
<b>WARNING: Use correct fuse</b> .....	10
Connecting SeaTalk or NMEA compasses .....	11
1.8 How to connect NMEA equipment .....	12
<b>WARNING: Connections to other equipment</b> .....	12
SmartPilot computer NMEA inputs/outputs.....	13
NMEA connectivity overview .....	13
1.9 How to connect optional components .....	14
GyroPlus yaw sensor.....	14
Handheld remotes .....	14
External alarm .....	15
Wind vane (sail boats) .....	15



- Off switch (S2 and S3 only)..... 15
  - Connecting spool valves (S2 and S3 only)..... 15
  - Selecting clutch voltage (S3 & S3G only)..... 16
- 1.10 Secure the cables ..... 17
  - S1 systems ..... 17
  - S2 and S3 systems ..... 17
- Chapter 2: SmartPilot Commissioning** ..... 19
  - WARNING: Calibration requirement** ..... 19
    - SmartPilot Controller Compatibility ..... 19
  - 2.1 Docksides Checks ..... 19
    - WARNING: Ensure safe control** ..... 19
    - Step 1 - Switch on..... 20
      - Troubleshooting ..... 20
    - Step 2 - Check the SeaTalk and NMEA connections..... 20
      - SeaTalk connections..... 20
      - NMEA navigator connections..... 21
      - Wind instrument connections..... 21
    - Step 3 - Check the autopilot operating sense ..... 21
      - Check the rudder position sensor ..... 21
      - Check the autopilot steering sense ..... 22
    - Step 4 - Adjust key SmartPilot settings ..... 22
      - Enter Dealer Calibration mode ..... 23
      - Set the vessel type ..... 23
      - Set the drive type ..... 25
      - Align the rudder position sensor ..... 26
      - Set the rudder limits ..... 26
      - Save the new settings ..... 26
  - 2.2 Seatrial Calibration ..... 27
    - Seatrial safety ..... 27
    - Calibrating the compass..... 28
      - Initial procedure ..... 28
      - Adjusting the heading alignment..... 31
    - Adjusting SmartPilot steering settings ..... 31
      - AutoLearn ..... 31
    - WARNING: AutoLearn safety** ..... 31
    - Manual set-up: Non-G Systems..... 34
      - Checking SmartPilot operation..... 34
      - Response level ..... 34
      - Adjusting the rudder gain ..... 35
      - Adjusting the counter rudder ..... 36
      - Further adjustments (Non-G) ..... 37



<b>Chapter 3: Adjusting SmartPilot Settings .....</b>	<b>39</b>
3.1 Calibration basics .....	39
Calibration groups .....	39
Accessing the Calibration modes .....	40
3.2 Display Calibration .....	41
Display Calibration screens .....	42
Display bar selection .....	42
Heading selection .....	42
Pop-up pilot time-out (ST7001, ST7002, ST8001 & ST8002 only) .....	42
Data pages .....	43
3.3 User Calibration .....	44
3.4 Seatrial Calibration .....	45
3.5 Dealer Calibration .....	45
Accessing Dealer Calibration .....	45
Dealer Calibration screens and settings .....	47
SeaTrial Calibration lock .....	47
Vessel type .....	47
Drive type .....	48
Align rudder .....	48
Rudder limit .....	49
Rudder gain .....	49
Counter rudder .....	49
Rudder damping .....	50
AutoTrim .....	50
Response level .....	51
Turn rate limit .....	51
Off course warning angle .....	52
Joystick mode (PWR STEER) .....	52
AutoRelease (I/O drives only) .....	53
AutoTack angle .....	53
Gybe inhibit .....	53
Wind selection .....	54
WindTrim (wind response) .....	54
Cruise speed .....	54
AutoAdapt .....	55
Latitude .....	55
System reset .....	56
<b>WARNING: Losing settings at system reset .....</b>	<b>56</b>
Dealer Calibration defaults .....	57
Dealer Calibration options .....	58

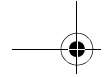

<b>Chapter 4: Fault Finding &amp; Maintenance</b> .....	59
4.1 Fault finding .....	59
SmartPilot alarm messages .....	60
4.2 Maintenance .....	62
EMC, servicing and safety guidelines .....	62
Product support .....	63
World wide web .....	63
Telephone help line .....	63
Help us to help you .....	63
<b>SmartPilot Specifications</b> .....	65
<b>WARNING: Potential ignition source</b> .....	66
<b>Glossary</b> .....	67
<b>Index</b> .....	69

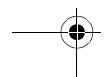
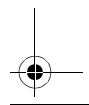
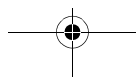
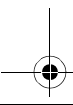
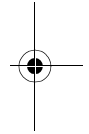
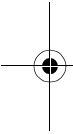

## Chapter 1: System Connections

This chapter describes how to connect the elements of the SmartPilot system together and integrate connections from other equipment on your boat.

### 1.1 Before you start

Ensure the following core elements of the system have been fitted in accordance with the supplied installation guides:

- Compass
- Rudder Reference
- SmartPilot Computer (S1, S1G, S2, S2G, S3, S3G)
- SmartPilot Controller (ST6001, ST6002, ST7001, ST7002, ST8001 or ST8002)
- Drive Unit

**Note:** For Volvo Penta IPS autopilot systems the rudder reference and drive units are not required. For more information, please refer to the Connections guide supplied with the DPU.

The remainder of this chapter covers the connection of these units. When complete, the core system will be connected like this:

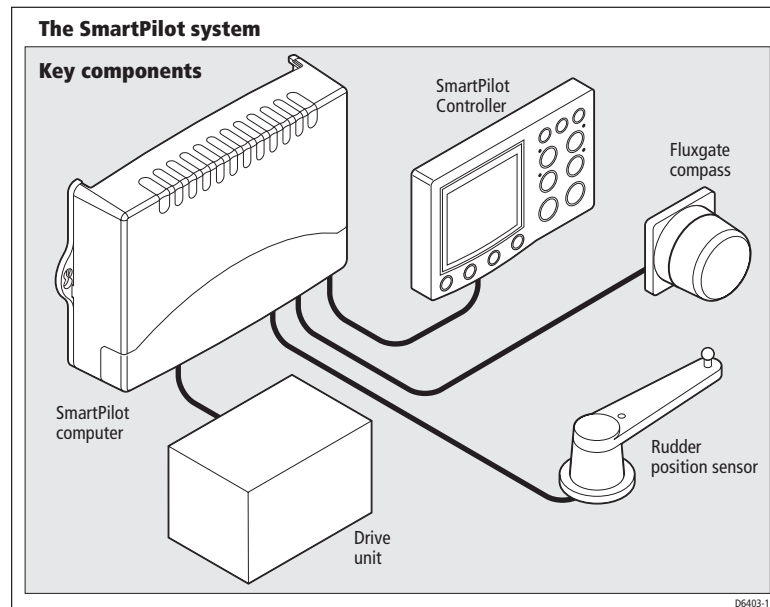

## 1.2 The SmartPilot computer

The SmartPilot computer lies at the heart of the autopilot system. It processes information from the sensors in the system so it can steer the boat using the drive unit:

- it contains a microprocessor and electronic circuitry to control the drive unit and the drive motor.
- it is the central distribution point for the autopilot system, with terminals to take power from the boat's distribution panel and inputs/outputs for all other autopilot components
- it has inputs/outputs for SeaTalk and NMEA so you can connect it to Raymarine and other manufacturer's equipment.

### SmartPilot types

S1G, S2G and S3G Smartpilots have a built-in yaw sensor (Gyro) which measures the boat's rate of turn. This information is used to enhance course keeping in adverse weather and sailing conditions.

Non-G systems do not contain a built-in Gyro. These can be upgraded with a dealer-fitted internal Gyro or connecting an external Gyro unit.

SmartPilot Version	Supply voltage	Drive unit compatibility	Built-in Gyro?
<b>S1G</b>	12 V	All Raymarine Type 1 12 V drives and pumps (excluding 12 V Constant Running pump).	Yes
<b>S1</b>	12 V	All Raymarine Type 1 12 V drives and pumps (excluding 12 V Constant Running pump).	No
<b>S2G</b>	12 V	All Raymarine Type 1 12 V drives and pumps (including 12 V Constant Running pump).	Yes
<b>S2</b>	12 V	All Raymarine Type 1 12 V drives and pumps (including 12 V Constant Running pump).	No
<b>S3G</b>	12 V or 24 V	All Raymarine 12 V and 24 V Type 1, Type 2 and Type 3 drives and pumps. Drive voltage must be matched to boat's supply voltage.	Yes
<b>S3</b>	12 V or 24 V	All Raymarine 12 V and 24 V Type 1, Type 2 and Type 3 drives and pumps. Drive voltage must be matched to boat's supply voltage.	No
<b>Volvo Penta IPS (S3G)</b>	12 V or 24 V	Only to be used with Volvo Penta IPS Drive systems.	Yes

## 1.3 Removing and replacing the connector cover

### WARNING: Electrical safety

**Before you make any electrical connections, ensure the power supply is switched off and you have read the EMC installation guidelines (see page iii.)**

#### S1 Systems

- hold the bottom of the connector cover
- gently lift the connector cover away from the base and the lid will come free

#### To open

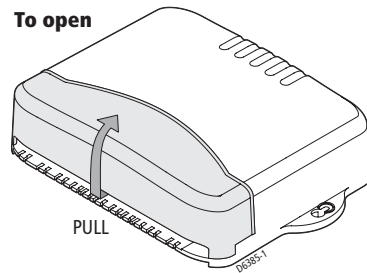

- replace the cover
- gently press the sides of the cover until you hear it click

#### To close

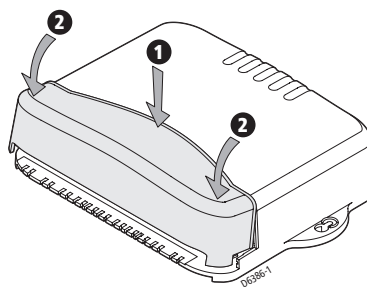

#### S2 and S3 Systems

- use a flat-bladed screwdriver or small coin to rotate the catch  $\frac{1}{4}$  turn (90°) in either direction – until you hear a click and the slot is horizontal
- lift off the cover

#### To open

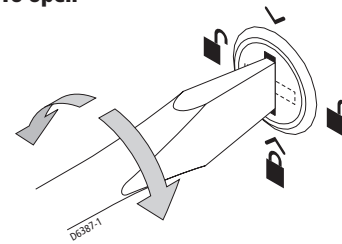

- replace the cover
- turn the catch so the slot is vertical
- push in the catch until you hear it click

#### To close

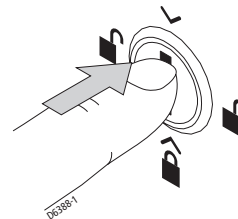

## Computer inputs, outputs and fuses

### S1 Systems

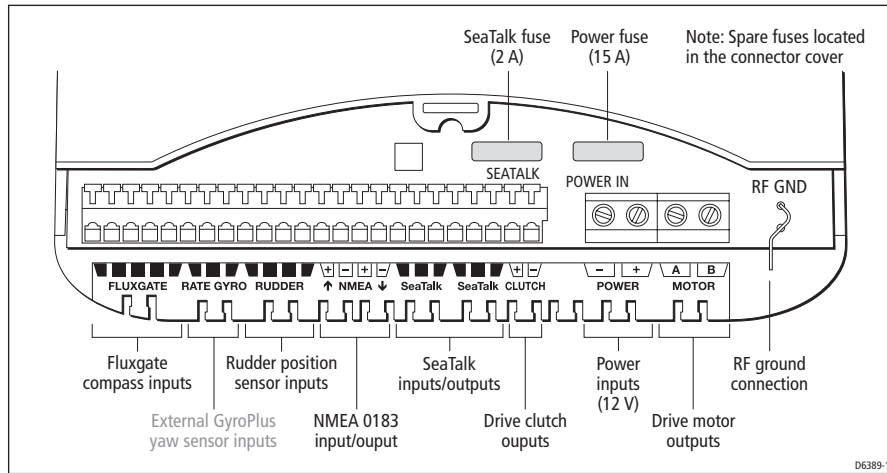

### S2 and S3 Systems

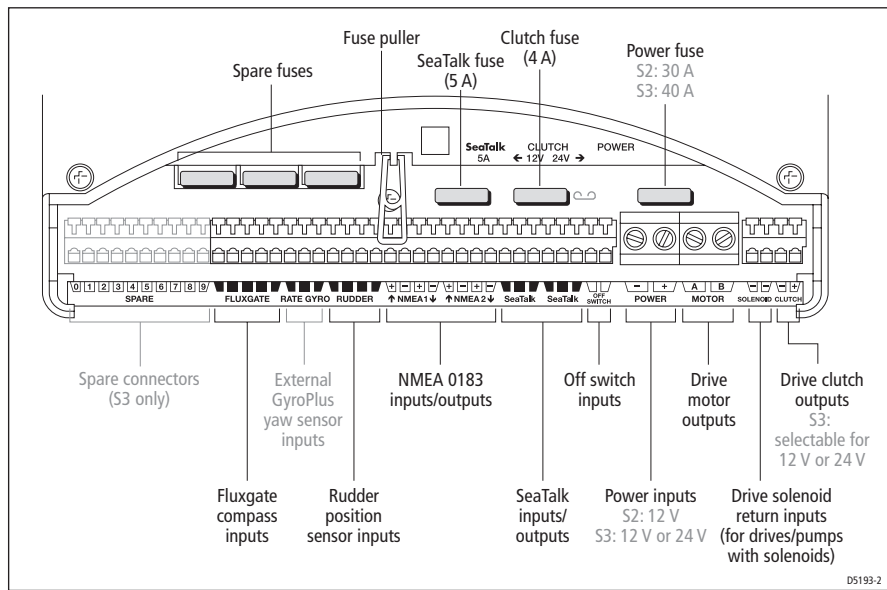

## 1.4 Connecting the Power and the Drive unit

### CAUTION:

**Use of incorrect power cable size could cause your SmartPilot to malfunction and will reduce the power supplied to the drive unit. Ensure the correct size is used and if in doubt, use a heavier gauge cable.**

**Note:** For Volvo Penta IPS autopilot systems a motor connection is not required. For more information, please refer to the Connections guide supplied with the DPU.

To connect the power and motor connections, follow the steps below:

1. Measure the total length of cable run from the boat's distribution panel to the SmartPilot computer.
2. Select the appropriate size cable (distribution panel to SmartPilot computer):

Cable length	S1	S2 & S3	Cable gauge	Copper area
<b>Type 1 drive 12/24 V; I/O drive;</b> Volvo Penta IPS system (S3G); CR pump solenoids* up to 3m (10ft) up to 5m (16ft) up to 7m (23ft) up to 10m (32ft)	↗ ↗ ↗	↗ ↗ ↗	14 AWG 12 AWG 10 AWG 8 AWG	2.5 mm <sup>2</sup> 4 mm <sup>2</sup> 6 mm <sup>2</sup> 10 mm <sup>2</sup>
<b>Type 2 drive 12 V</b> up to 5m (16ft) up to 7m (23ft)		↗ ↗	10 AWG 8 AWG	6 mm <sup>2</sup> 10 mm <sup>2</sup>
<b>Type 2 drive 24 V</b> up to 3m (10ft) up to 5m (16ft) up to 10m (32ft)		↗ ↗ ↗	12 AWG 10 AWG 8 AWG	4 mm <sup>2</sup> 6 mm <sup>2</sup> 10 mm <sup>2</sup>
<b>Type 3 drive 12 V</b> up to 5m (16ft)		↗	8 AWG	10 mm <sup>2</sup>
<b>Type 3 drive 24 V</b> up to 5m (16ft) up to 7m (23ft)		↗ ↗	10 AWG 8 AWG	6 mm <sup>2</sup> 10 mm <sup>2</sup>

**Note:** \* These specifications apply to the cabling for CR solenoids. Power the CR pump motor separately, as specified in the CR pump installation guide.

## 3. Select the appropriate circuit breaker or fuse:

Drive unit	S1	S2 & S3	Fuse	Thermal over-current circuit breaker
Rotary, linear, hydraulic pump,	„	„	25 A	20 A
hydraulic linear	„	„	25 A	20 A
Type 1: 12 V	„	„	40 A	30 A
Type 1: 24 V	„	„	30 A	30 A
Type 2: 12 V	„	„	40 A	30 A
Type 2: 24 V	„	„	40 A	30 A
Type 3: 12 V and 24 V	„	„		
I/O drive	„	„	15 A	10 A
CR pump solenoids	„	„	10 A	10 A
Volvo Penta IPS system (S3G)	„	„		

## 4. Route the cables back to the SmartPilot computer.

5. Connect the cables to the **POWER** inputs.**S1 Systems**

- Strip 8–10 mm (1/2 in) of insulation from the end of each cable.
- Use a small screwdriver to loosen the screw on the terminal block.
- Insert the stripped cable into the terminal and tighten the screw.

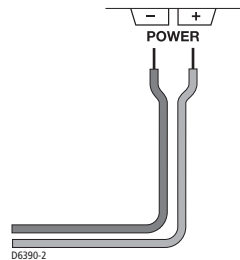
**S2 & S3 Systems**

- Strip 8–10 mm (1/2 in) of insulation from the end of each cable.
- For the **POWER** connection: Attach the suppression ferrite (supplied) around both the positive and negative power cables, between the cable clamp and SmartPilot computer. When you attach the ferrite, you must loop both power cables so that the ferrite encloses two passes of each cable. Secure the ferrite with the small tie-wrap.
- Use a small screwdriver to loosen the screw on the terminal block.
- Insert the stripped cable into the terminal and tighten the screw.

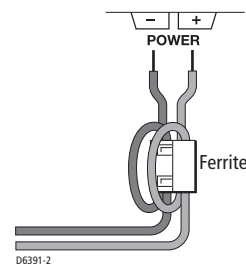



6. Connect the drive cables to the **MOTOR** inputs. These cables can be connected any way round as their orientation is verified later in the process.

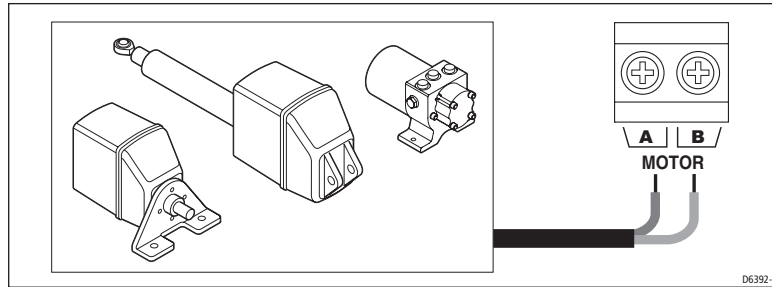

### Grounding the SmartPilot

#### S1 Systems

**CAUTION:**

**S1 systems MUST be connected to ships ground.**

Failure to connect the SmartPilot to ships ground may cause it, or other on-board electronics to function incorrectly.

- Use flat tinned copper braid, 30 A rating (1/4 in) or greater. Equivalent stranded wire diameter 4mm or greater.
- Using the supplied yellow (1/4 in) female spade connector, connect the braid to RF GND on the SmartPilot computer.
- The other end of the earth strap should be connected to metal in contact with the water. If this is not possible, it can be connected to the negative pole of the battery (ideally at the battery itself).
- Keep the length of the earth strap as short as possible

#### S2 & S3 Systems

**CAUTION:**

**S2 & S3 systems MUST NOT be connected to ships ground.**

If the installed location has a metallic surface, you **must** insulate the base of the computer so it is not earthed.

#### S1 systems only

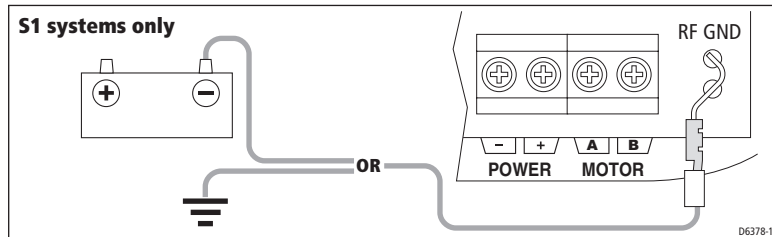

## 1.5 Fuse Protection

The **POWER** and **SeaTalk** terminals are fuse protected against short-circuits and misconnections.

Your SmartPilot computer is supplied with spare fuses. The fuses used in the computer are standard automotive blade fuses, so replacements are easily available. Your Raymarine dealer can also provide a replacement fuse pack.

## 1.6 How to connect SmartPilot system elements

All SmartPilot computer terminals will accept stranded cable up to 2.5 mm<sup>2</sup> (14 AWG).

Connect the following elements as shown in the diagram:

1. Compass
2. Rudder Sensor
3. SmartPilot Controller via SeaTalk

**Note:** For Volvo Penta IPS autopilot systems a rudder sensor is not required. For more information, please refer to the Connections guide supplied with the DPU.

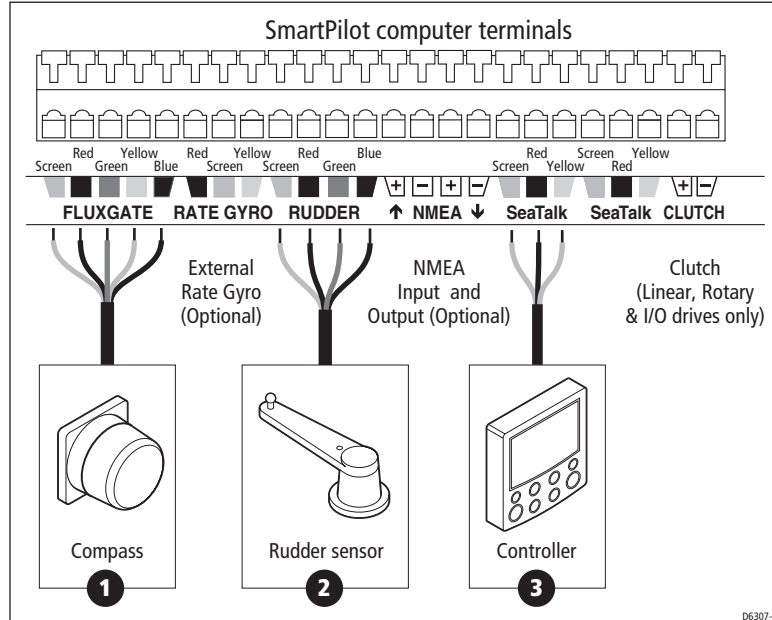

## Securing the Cables

1. Strip at least 5 mm (1/4 in) of insulation from the end of each cable
2. Use a small screwdriver to push the small plastic lever on top of the terminal and release the cable clamp
3. Insert the stripped cable and release the lever to grip the cable

## 1.7 How to connect SeaTalk equipment

**Note:** For Volvo Penta IPS autopilot systems, please refer to the Connections guide supplied with the DPU.

You can use SeaTalk to connect your SmartPilot to:

- additional SeaTalk controllers: you can use any controller to operate the SmartPilot and view autopilot information
- SeaTalk equipment (such as instruments, chartplotters, radar and GPS):
  - the SmartPilot can use information from this equipment to enhance course keeping and provide additional features.
  - you can also display information from the SeaTalk equipment on the SmartPilot controller.

The following illustrations show some typical ways to connect simple SeaTalk systems.

### Single control unit, single power supply

The simplest type of system has the SmartPilot computer providing power to a single SeaTalk bus that includes a single controller and several instruments.

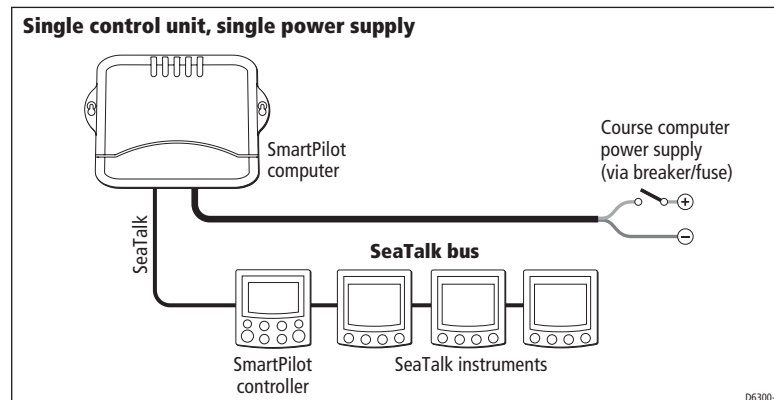

### Isolated control unit, single power supply (S2 and S3 computers only)

If you have two control units, we recommend that you connect one to each SeaTalk terminal. In the following illustration:

- the SmartPilot computer provides power to the SeaTalk system
- one control unit is connected on its own to SeaTalk A so it is isolated against any possible failure of SeaTalk B

If the SeaTalk B line fails, the isolated control unit will switch to Standby mode as a safety measure. By pressing **auto** on the isolated control unit you can regain full autopilot control.

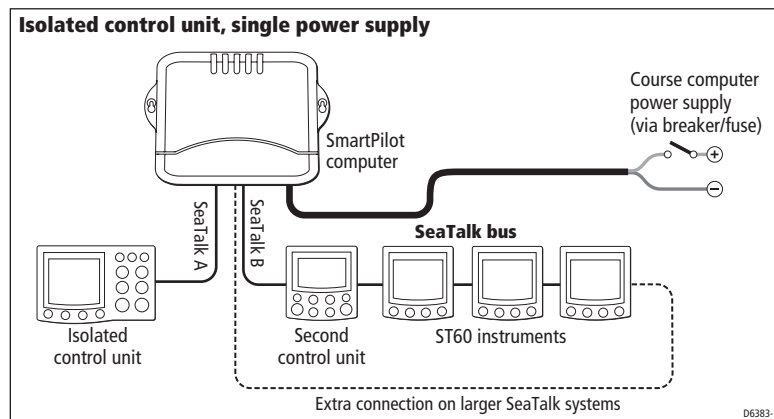

**Note:** Depending on the number of SeaTalk units and the total length of SeaTalk cabling, you may need to provide 12 V power supply to each end of the SeaTalk bus ('ring-main' style). Refer to the instrument handbook for more information.

### Separate SmartPilot computer and instrument power

Another option is to provide separate power supplies to the SmartPilot computer and SeaTalk system so you can have independent, switched instrument and pilot systems.

**Note:** DO NOT connect the SeaTalk RED wire at the SmartPilot terminal



#### WARNING: Use correct fuse

**The fuse supplying the instrument system MUST be rated at 5A or less.**

The behavior of the computer and the instruments now depend on where power is applied to the system.

- **Computer AND instrument power supplies ON:**  
The system will function normally.
- **Only computer power supply ON:**  
The controller and instruments do not power up.
- **Only instrument power supply ON:**  
The controller shows a PILOT OFF or NO LINK message.

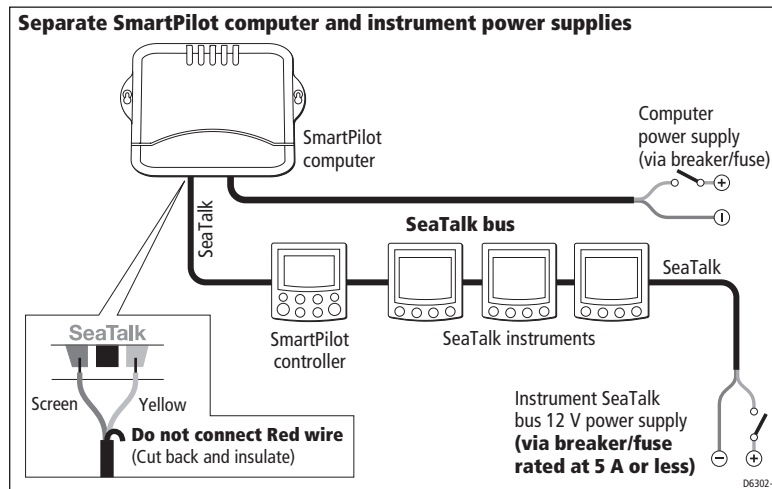

### Connecting SeaTalk or NMEA compasses

You can connect SeaTalk or NMEA compasses to the SmartPilot computer, either to replace the fluxgate compass or provide supplementary compass signals.

When you connect more than one compass to the autopilot system, the computer processes their signals in this order of priority:

1. Fluxgate compass
2. NMEA compass
3. SeaTalk compass

This means that if you want to use a NMEA compass as the primary compass, you need to disconnect the fluxgate compass.

To connect a SeaTalk or NMEA compass to the autopilot system:

- **NMEA compass:** connect it to a NMEA input on the computer
- **SeaTalk compass:** connect it to the SeaTalk bus or the SeaTalk terminals

## 1.8 How to connect NMEA equipment

If you have equipment on your boat that transmits or receives NMEA 0183 data (e.g. GPS), you can connect this equipment to the SmartPilot. NMEA equipment can be connected in any combination of these ways:

- using the SmartPilot computer NMEA input/output
- using the NMEA input on the back of the SmartPilot controller. (Refer to the Controller handbook for NMEA data details)
- using the SeaTalk/NMEA interface (part number: E85001) to convert the NMEA data to SeaTalk data



### **WARNING: Connections to other equipment**

**If you are connecting Raymarine equipment to other equipment using a non-Raymarine cable, you MUST attach an appropriate suppression ferrite to the cable near to the Raymarine unit.**

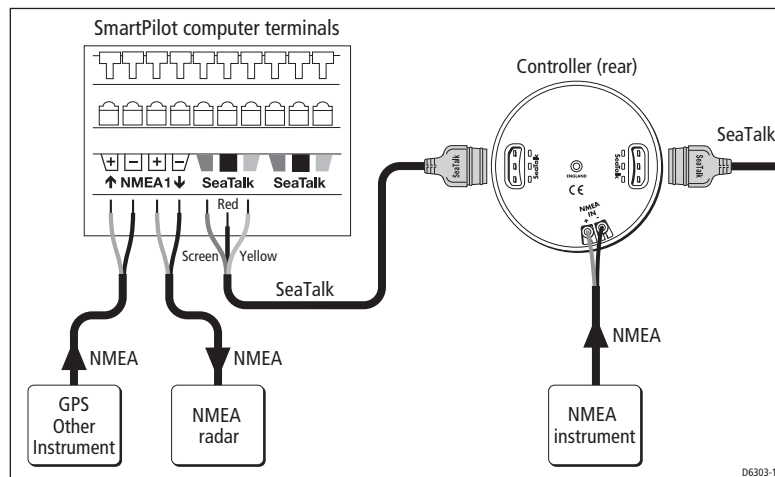

## SmartPilot computer NMEA inputs/outputs

**Note:** Do NOT connect more than one piece of equipment to each SmartPilot computer NMEA input.

### NMEA connectivity overview

#### S1 Systems

The S1 has a single NMEA input/output to receive and transmit information from NMEA equipment.

#### S2 & S3 Systems

S2 and S3 systems have two sets of NMEA inputs/outputs to receive and transmit information from NMEA equipment.

#### SmartPilot computer NMEA inputs

NMEA 0183 received	S1	S2 & S3	Information extracted
APB	„	„	cross track error, bearing to waypoint, waypoint number
BWC BWR	„ „	„ „	bearing to waypoint, distance to waypoint, waypoint number, time
GGA GLL	„ „	„ „	latitude/longitude, time
HDG HDM HDT	„ „ „	„ „ „	heading
MWV	„	„	apparent wind angle, apparent wind speed
RMA	„	„	course over ground (COG), speed over ground (SOG), latitude/longitude, variation
RMB	„	„	cross track error, bearing to waypoint, distance to waypoint, waypoint number
RMC	„	„	course over ground (COG), speed over ground (SOG), latitude/longitude, time, variation
VHW	„	„	speed through water, heading
VTG	„	„	course over ground (COG), speed over ground (SOG)
VWR	„	„	relative apparent wind angle, relative apparent wind speed
XTE	„	„	cross track error
ZDA	„	„	time, date

**Note:** When connected to a NMEA navigator, S2 & S3 systems look at NMEA 1 first. If NMEA 1 has no data, it then looks at NMEA 2. If both channels have the same type of navigation data, NMEA 1 is used.

<b>SmartPilot computer NMEA outputs*</b>			
<b>NMEA 0183 sent</b>	<b>S1</b>	<b>S2 &amp; S3 (NMEA port)</b>	<b>Information sent</b>
BWC	,	2	bearing to waypoint*, distance to waypoint*, waypoint number*, time*
GLL	,	2	latitude/longitude*, time*
HDG	,	2	
HDM	,	1 & 2	heading
HDT	,	2	
VTG	,	2	course over ground* (COG), speed over ground* (SOG)

\* **Note:** The computer will only transmit these items if it has received the appropriate data.

- Notes:**
- (1) *S1G systems provide fast heading (HDM) output at 5 Hz 0.1° resolution*
  - (2) *S2G & S3G computers provide fast heading (HDM) output at 10 Hz 0.1° resolution.  
This fast heading data is suitable for use with the MARPA function on radar equipment.*
  - (3) *In Volvo Penta IPS systems, NMEA port 1 is reserved for connection to the DPU, NMEA port 2 remains available for general purpose NMEA connections. For more information, please refer to the Connections guide supplied with the DPU.*

## 1.9 How to connect optional components

**Note:** For installation, refer to the guide supplied with the component.

### GyroPlus yaw sensor

Non-G SmartPilots do not contain a built-in Gyro, but you have the option of adding:

- an external GyroPlus (part number: E12101)
- or a dealer-fitted internal GyroPlus (part number: A18069)

### Handheld remotes

Two wireless Raymarine handheld remote control systems are available:

- the Smart Controller system can act as the sole pilot controller in your system or as a full-function remote for systems with other fixed pilot controllers.
- the compact S100 Controller system gives you full course control away from the main steering position



## External alarm

The SmartPilot sounds all critical alarms from all controllers. On large or noisy boats you can fit a Raymarine external alarm (part number: Z035, connected through E85001 interface box) as a high volume audible repeater.

## Wind vane (sail boats)

The SmartPilot computer can use wind angle information from a wind vane or instrument to maintain a course relative to the wind. You can provide wind angle information to the autopilot system by connecting it to a suitable SeaTalk or NMEA instrument (providing wind angle and speed information)

## Off switch (S2 and S3 only)

The SmartPilot computer has inputs so you can fit an off switch if required. By closing a circuit, this switch will turn off the computer power supply.

Connect a suitable off switch to the **OFF SWITCH** inputs on the computer.

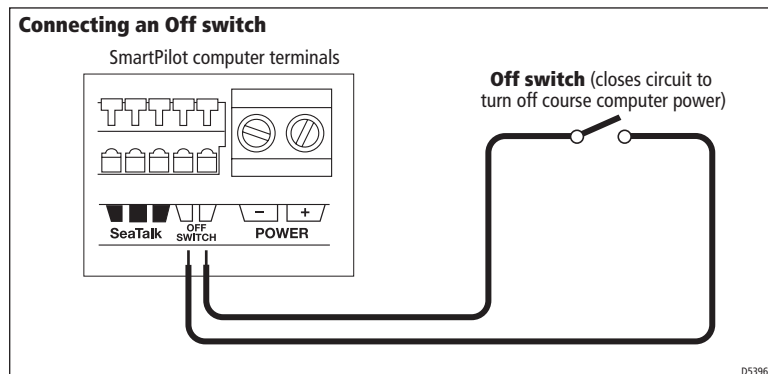

## Other manufacturers' drive units (S2 and S3 only)

If you are connecting another manufacturer's drive unit, refer to the specifications (see *page 65*) for information on the SmartPilot computer's drive motor, drive clutch and drive solenoid terminals. Connect the drive unit to these terminals as necessary. For more information, contact the drive unit manufacturer.

## Connecting spool valves (S2 and S3 only)

If the drive has spool valves, connect them to the motor and solenoid terminals on the computer as shown below. The computer provides a negative ground for the spool valves even when it is switched off.

**CAUTION:**

**Do NOT connect the solenoid return cables to boat's negative ground, as this will bypass the current protection devices inside the SmartPilot computer.**

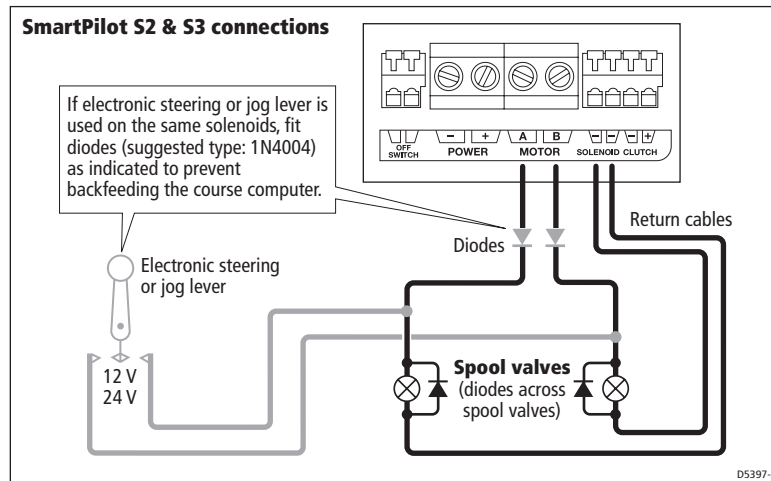

**Selecting clutch voltage (S3 & S3G only)**

You can use the S3 and S3G SmartPilot computers with other manufacturers' drives that have either 12 V or 24 V clutches. If you do this, you may have to reposition the clutch fuse.

**Important:** All Raymarine 12 V and 24 V drive units with a clutch have a 12 V clutch, so you do NOT need to re-position the clutch fuse.

If you are using another manufacturer's drive, ascertain the operating voltage of the CLUTCH. Ensure the clutch fuse is set to the correct voltage, i.e. to the left for a 12 V clutch, or right for a 24 V clutch. If necessary, select the appropriate clutch voltage by re-positioning the clutch fuse.

It is important to appreciate that the fuse position does NOT depend on the voltage used on your boat, but on the operating voltage of the CLUTCH.

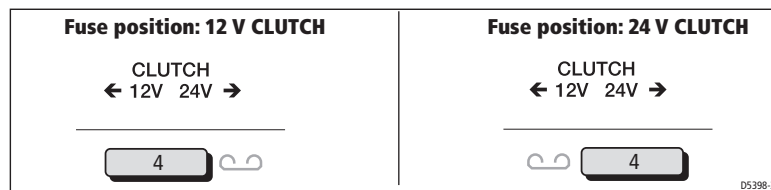

## 1.10 Secure the cables

### S1 systems

To prevent strain on the connector blocks, secure the cables to the SmartPilot computer with cable ties as shown below.

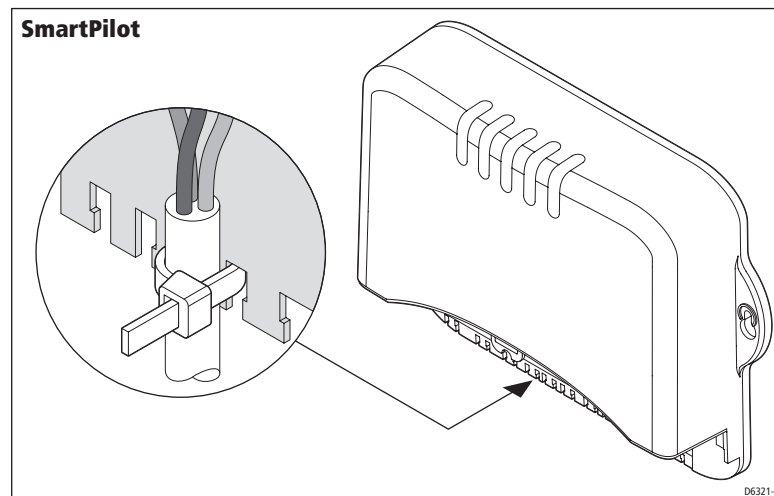

### S2 and S3 systems

When you have connected all autopilot system components, we recommend that you use the supplied cable clamp to relieve any strain on the cable connections.

Referring to the illustrations below, secure the cables with the cable clamp as follows:

1. Hold the cable clamp in place below the computer, making sure:
  - its center hole is below the center of the computer (i.e. in line with the connector cover catch)
  - it is at least 50 mm (2 in) from the bottom of the computer
  - the hole locations are clear of any cables
2. Mark the position of the three holes, then remove the cable clamp.
3. Drill the three pilot holes using a 3 mm ( $1/8$  in) drill bit.

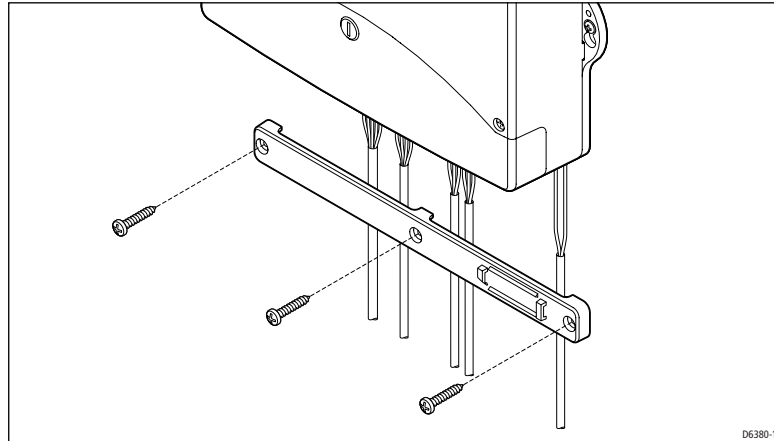

4. Secure the cable clamp using the self-tapping screws supplied (No 8 x  $3/4$  in, pan-head), making sure:
- the tie-wrap securing loops are on the right (below the **POWER** and **MOTOR** terminals on the computer)
  - the clamp securely holds all cables
  - the legs on cable clamp do not pinch any of the cables

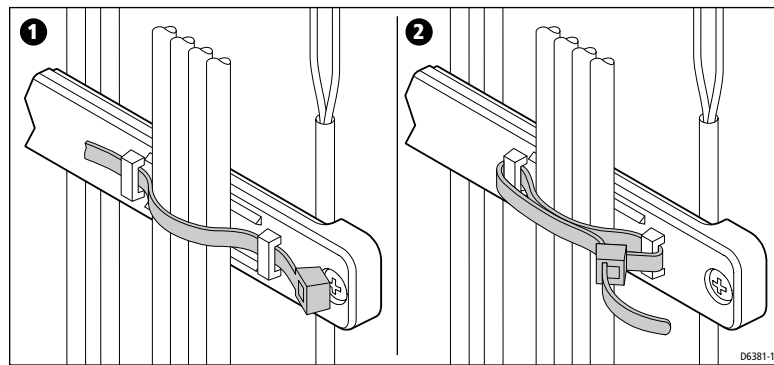

**Note:** If the power and/or motor cables are larger than 5 mm ( $1/4$  in) diameter, secure them on top of the cable clamp with the tie-wrap supplied. Make sure the tie-wrap sits above the cables (as shown below), so it pulls the cables against the clamp when tightened.

## Chapter 2: SmartPilot Commissioning

This chapter will guide you through the commissioning process for your Raymarine autopilot. This comprises a series of dockside safety checks followed by a short seatrial calibration.



**WARNING: Calibration requirement**  
All autopilot systems must be calibrated before use.

### SmartPilot Controller Compatibility

This SmartPilot system can be commissioned using any of the available SmartPilot controllers. There are some differences in the method of control and these are defined in the table below.

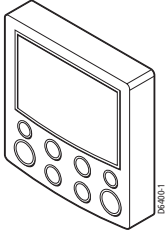
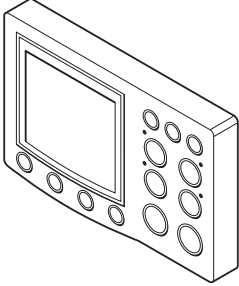
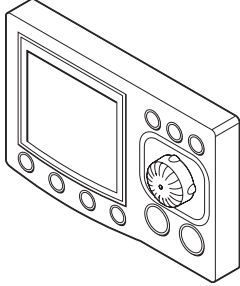
ST6001 & ST6002 Controller	ST7001 & ST7002 Controller	ST8001 & ST8002 Controller
		
<ul style="list-style-type: none"> <li>• <b>standby &amp; auto</b> function keys</li> <li>• <b>+1, -1, +10 &amp; -10</b> course change keys</li> <li>• <b>disp &amp; track</b> extended function keys</li> </ul>	<ul style="list-style-type: none"> <li>• <b>standby &amp; auto</b> function keys</li> <li>• <b>+1, -1, +10 &amp; -10</b> course change keys</li> <li>• <b>resp, track, mode, res'm, disp, up &amp; down</b> extended function keys</li> </ul>	<ul style="list-style-type: none"> <li>• <b>standby &amp; auto</b> function keys</li> <li>• <b>Rotary</b> course change control</li> <li>• <b>resp, track, mode, res'm, disp, up &amp; down</b> extended function keys</li> </ul>

### 2.1 Dockside Checks



**WARNING: Ensure safe control**  
For safe control of your boat, you **MUST** complete the dockside checks before starting the initial seatrial.

With the boat safely tied up, complete the following dockside checks:

## Step 1 - Switch on

1. When you have installed your SmartPilot system, switch on the main power breaker.
2. If the SmartPilot controller and computer are active, the controller will beep, show the controller type for a few seconds will show the **STANDBY** screen. You may see a **CALIBRATE REQUIRED** message. This is displayed for a short time if either:
  - the vessel type is not selected
  - the compass is not calibrated
 These will be calibrated later in this chapter.
3. Check that the **STANDBY** screen displays a live compass heading and a rudder angle.

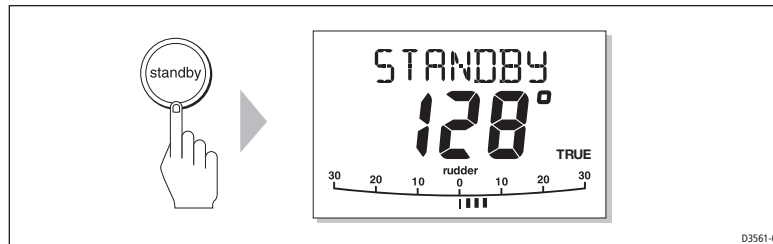

## Troubleshooting

- If the SmartPilot controller does not beep or the display is blank, check the fuse/circuit breaker and the SeaTalk fuse in the SmartPilot computer.
- If the display shows the SEATALK FAIL or NO DATA alarm message, check the SeaTalk connections.
- If the **STANDBY** screen does not display a live compass heading or a rudder angle, check the sensor connections.

## Step 2 - Check the SeaTalk and NMEA connections

### SeaTalk connections

If you have connected the SmartPilot controller to other existing SeaTalk instruments or controllers, check the links as follows:

1. Select display lighting level 3 (**LAMP 3**) on one of the other SeaTalk instruments or controllers.
2. The SmartPilot should immediately switch on its display lighting:
  - if the lighting does not switch on, check the SeaTalk cabling between the SmartPilot and the other units.

### NMEA navigator connections

If you have connected the SmartPilot to a NMEA navigator, check the links by displaying the default navigation data pages on the SmartPilot controller:

- press **disp** to display the first data page (XTE), and check that this page shows the expected data.
- press **disp** again to check each successive data page (BTW, DTW etc)

If the display shows dashes instead of data values, check for the following:

- the navigator is not switched on or not transmitting an active waypoint
- a cabling error. Check for open circuit, short circuit or reversed wires
- the navigator is not configured to transmit the required data format

### Wind instrument connections

- If you have connected the SmartPilot to a NMEA or SeaTalk wind instrument, check the links by pressing **standby** and **auto** together:
- the SmartPilot should display the Wind Vane mode screen, with the locked wind angle and locked heading.

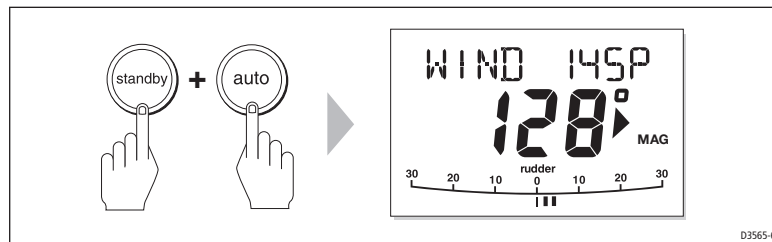

- if the controller does not display WIND mode, the SmartPilot is not receiving wind data. Check the wind instrument and connections.

## Step 3 - Check the autopilot operating sense

### Check the rudder position sensor

1. Turn the wheel manually to starboard.
2. Check that the rudder bar on the controller moves to starboard.

If the rudder bar display moves the wrong way:

- i. turn off the power
- ii. reverse the red and green wires connected to the **RUDDER** inputs on the SmartPilot computer
- iii. switch on the power and re-check

### Check the autopilot steering sense

1. Manually center the wheel, then press the **auto** key so the SmartPilot is in Auto mode. Check that the display shows AUTO.  
**Be ready to press standby if the rudder moves hardover.**
2. Press the **+10** key once or turn the **rotary control ½ turn** clockwise.

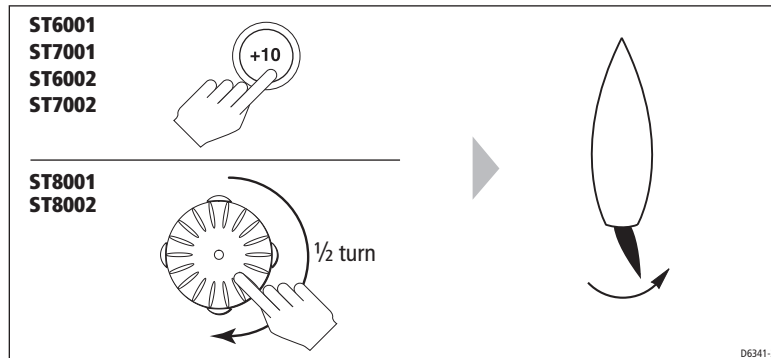

3. Check that the rudder moves to starboard a few degrees and then stops.
  - if the rudder drives hardover, immediately press **standby** to prevent further rudder movement
4. If the rudder moves to port or the rudder drives hardover:
  - i. press **standby**
  - ii. turn off the power
  - iii. reverse the motor wires connected to the SmartPilot computer
  - iv. switch on the power and re-check

**Note:** *If the rudder overshoots and has to drive back or starts to hunt back and forth, you will need to increase the rudder damping level manually (See page 50).*

### Step 4 - Adjust key SmartPilot settings

The next step in the commissioning process requires the adjustment of some key settings. To achieve this you will need to enter one of the four calibration modes, Dealer Calibration. For more information on the various calibration modes and their uses see *Chapter 3, Adjusting Settings*.



## Enter Dealer Calibration mode

As improper use of the Dealer Calibration settings can seriously impair SmartPilot performance, we have made entry to the Dealer Calibration mode more difficult. Ensure you follow the instructions in this step carefully.

1. Start with the SmartPilot in STANDBY mode.
2. Enter DEALER CAL as follows:

### ST6001/ST6002 Controllers

- press and hold the **standby** key for two seconds to enter the Calibration mode
- when the screen shows DISPLAY CAL, press the **disp** key until you see the DEALER CAL screen
- press the **auto** key: the display will change to CAL?
- press **-1** and **+1** together to enter Dealer Calibration mode

### ST7001 /ST7002 and ST8001/ST8002 Controllers

- press and hold the **standby** key for two seconds to enter the Calibration mode
- when the screen shows DISPLAY CAL, press the **disp, up or down arrow key** until you see the DEALER CAL screen
- press the **auto** key: the display will change to CAL?
- press **-1** and **+1** together (ST7001/ST7002) or press **up and down arrow keys** together (ST8001/ST8002) to enter Dealer Calibration mode

**Note:** For more information on SmartPilot settings, refer to Chapter 3:

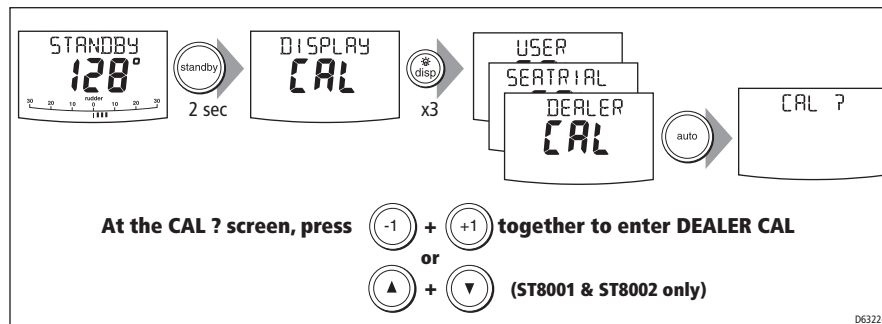

## Set the vessel type

When you select a vessel type, the SmartPilot automatically selects appropriate default values for various other calibration settings.

Some of these settings will be checked later in this procedure and the remained should not require any adjustment. The default values for each vessel type are listed on *page 57*.

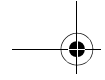

To set the vessel type:

1. Use the **disp** key to scroll through the Dealer Calibration pages until the display shows either **VESSEL** or one of the vessel types (e.g. **DISPLACE**).
2. Use the **-1** or **+1** keys or the **rotary control** to select your vessel type:

---

**Options**

---

DISPLACE	Power-driven boats which do not plane (Typically below 15 kts top speed)
SEMI DISPLACE	Faster power-driven boats which do not plane (Typically 15-20 kts top speed)
PLANING	Planing boats with inboard engine(s) and shaft drives (NOT boats with outdrives)
STERN DRV	Boats with outdrives or outboard engines
WORK BOAT	Commercial tugs, fishing vessels, etc
SAIL BOAT	Sailing boat

---

3. Press **disp** to select the new type of boat and move to the next calibration option.

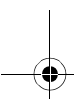
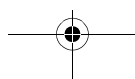
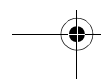
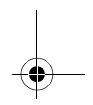
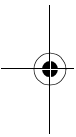
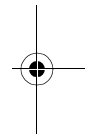

## Set the drive type

SmartPilot systems are designed to operate with a wide range of steering drives. Use this calibration setting to select the fitted drive type.

1. With the SmartPilot still in Dealer Calibration, use the **disp** key to scroll through the calibration pages until you reach the DRIVE TYP page.
2. Use the **-1** or **+1** keys or the **rotary control** to select the appropriate drive type:

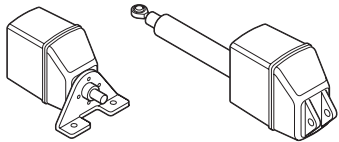
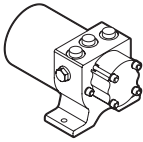
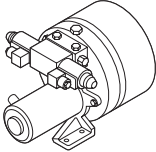
Drive	Drive Type Setting
 <p style="text-align: right; font-size: small;">D6404-1</p>	<p><b>Drive Type 3</b></p> <ul style="list-style-type: none"> <li>•Linear</li> <li>•Rotary</li> </ul> <p>Typically found on yachts</p> <ul style="list-style-type: none"> <li>•I/O (stern)</li> </ul> <p>Found on Powerboats</p>
 <p style="text-align: right; font-size: small;">D6405-1</p>	<p><b>Drive Type 4</b></p> <ul style="list-style-type: none"> <li>•Hydraulic reversing pump</li> </ul> <p>Used on yachts and powerboats with hydraulic steering</p>
 <p style="text-align: right; font-size: small;">D6406-1</p>	<p><b>Drive Type 5</b></p> <ul style="list-style-type: none"> <li>•Constant running hydraulic pumps. Controlled by solenoid valves</li> </ul> <p>Found on light commercial and larger boats (S2 and S3 systems only)</p>

3. Press **disp** to select the drive type and move to the next calibration option.



### Align the rudder position sensor

1. With the SmartPilot still in Dealer Calibration, press the **disp** key to scroll through the calibration pages until you reach the ALIGN RUD page.
2. Center the rudder using the wheel.
3. Use the **-1** and **+1** keys or the **rotary control** to adjust the rudder bar so it reads at center.
  - the maximum adjustment available is  $\pm 9^\circ$  for S1 systems, and  $\pm 7^\circ$  for S2 & S3 systems. If the offset is beyond these limits, you will need to physically adjust the alignment of the sensor.
4. Press **disp** to select the correct alignment and move to the next calibration option.

**Note:** *Alternatively, you can zero the rudder bar with the boat underway during the initial seatrial, by manually steering a straight course then accessing the ALIGN RUD screen in Seatrial Calibration to adjust the offset.*

### Set the rudder limits

1. With the SmartPilot still in Dealer Calibration press the **disp** key to scroll through the calibration pages until you reach the RUD LIMIT page.
2. Turn the wheel to move the rudder:
  - to the port end stop and note the angle on the rudder bar
  - to the starboard end stop and note the angle on the rudder bar
3. Use the **-1**, **+1**, **-10** and **+10** keys or the **rotary control** to set the rudder limit to  $5^\circ$  less than the lowest angle you have noted.
4. Press **disp** to select the new value and move to the next calibration option.

### Save the new settings

When you have adjusted these basic settings in Dealer Calibration:

- press and hold **standby** for two seconds, your changes will be saved
- once saved, the controller will return to the STANDBY display

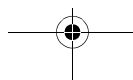
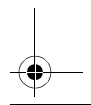
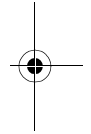

## 2.2 Seatrial Calibration

When you have completed the dockside calibration, you must complete SmartPilot setup by taking the boat on a short seatrial to:

1. Calibrate the compass:
  - complete the automatic deviation correction
  - align the compass heading
2. Adjust SmartPilot settings to suit your boat:
  - automatically on S1G, S2G and S3G systems
  - manually on Non-G systems

To achieve this you will need to enter another of the four calibration modes, Seatrial Calibration. For more information on the various calibration modes and their uses see *page 39*.

### Seatrial safety

#### **CAUTION: EMC conformance**

**Always check the installation before going to sea to make sure that it is not affected by radio transmissions, engine starting etc.**

#### **IMPORTANT**

**You can return to manual steering at any time during the seatrial by pressing the standby key.**

You should only perform the initial seatrial:

- when you have successfully completed the dockside calibration
- in conditions of light wind and calm water, so you can assess SmartPilot performance without the influence of strong winds or large waves
- in waters that are clear of any obstructions, so the boat has plenty of clear space to maneuver

**Note:** *Before you start your seatrial, make sure you have switched on any ancillary equipment – such as a GPS (providing course over ground (COG), speed over ground (SOG) and latitude (LAT) data) or a speed log (providing speed through the water). This information will help the SmartPilot achieve best performance.*

## Calibrating the compass

**Note:** *This section does not apply if you have connected an NMEA compass to your SmartPilot. Refer to the handbook supplied with the NMEA compass for information about calibration.*

Deviating magnetic fields can cause significant compass errors on your boat. The correction procedure reduces these errors to a few degrees, so you **MUST** perform this procedure as the first item in your initial seatrial. The SmartPilot will then automatically correct the compass.

### CAUTION:

**Failure to complete the deviation correction will impair your SmartPilot's performance on some compass headings.**

The deviation correction procedure (commonly called "swinging the compass") involves turning your boat in slow circles so the SmartPilot can determine the deviation and calculate any correction required. You must carry out this procedure in calm conditions and preferably on flat water.

### Initial procedure

#### Automatic compass deviation correction

- With the pilot in Standby mode, enter Seatrial Calibration as follows (see the following illustration):
  - press and hold **standby** for two seconds to enter Calibration mode
  - when you see the DISPLAY CAL screen, press **disp** until you see the SEATRIAL CAL screen
  - press **auto** to enter Seatrial Calibration

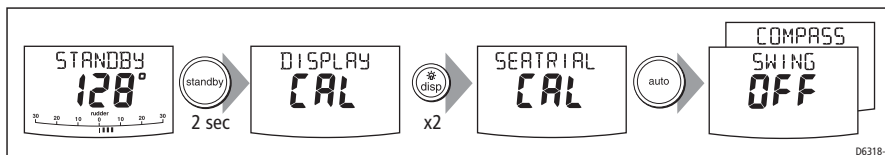

**Note:** *If you cannot access Seatrial Calibration, you need to disable the calibration lock. This can be found in Dealer Calibration (see page 47).*

- The first page in Seatrial Calibration should be the SWING COMPASS page. If this is not the case, use the **disp** key to page through the Seatrial Calibration items until you see SWING COMPASS

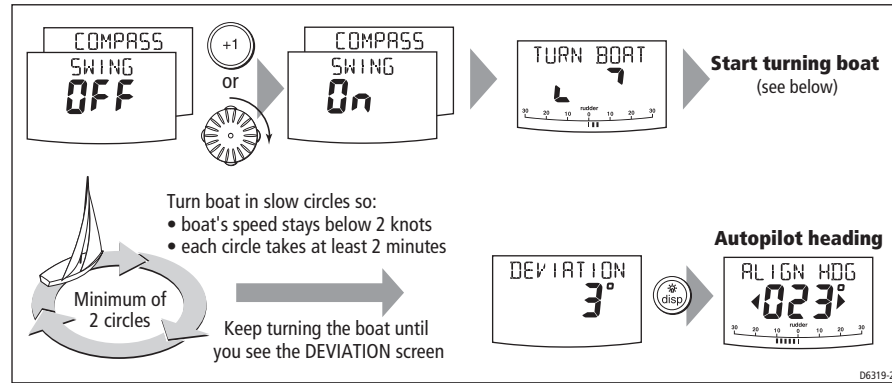

- When you are ready to start, press **+1**, or turn the **rotary control** clockwise, to select **SWING COMPASS ON**. (On ST8001 & ST8002 systems, you must then press **auto** to start the compass swing)  
The controller will display **TURN BOAT** indicating the start of the calibration process.

- Start turning the boat in slow circles (with the boat's speed below 2 knots). You will need to complete at least two circles, taking at least 2 minutes to complete each 360°:
  - the display will show a **TOO FAST** message if you turn the boat too quickly for the SmartPilot computer to correct the compass.

**Apply less helm to turn in a larger circle**

**Note:** *If necessary, you can quit the correction process by pressing the **standby** or **disp**. If you then want to repeat the deviation correction, return to the **SWING COMPASS** screen.*

- Continue slowly turning the boat until the controller beeps and displays the **DEVIATION** screen. This indicates that the SmartPilot has completed the deviation correction.

**Note:** *This screen shows the maximum deviation encountered over 360° (not as an east/west value).*

If the deviation figure exceeds 15° or the display shows no deviation value, the compass is being affected by ferrous objects on your boat. You should move the compass to a better location. Higher deviation figures are acceptable on steel boats.

### Aligning the compass heading

- Once the deviation is displayed, press **disp** to move to the Heading Alignment page (ALIGN HDG).
- Manually steer the boat on a steady course at a speed which enables you to hold that course.
- If you have a GPS connected to your SmartPilot:
  - increase the boat speed to more than 3 knots
  - press **auto**: the SmartPilot will then set the heading to agree with the COG (course over ground) heading received from the GPS
  - as many factors can cause a difference between heading and COG (such as tides and leeway affecting the boat) you must then fine-tune the heading alignment so it matches the boat's steering compass or a known transit bearing
- Use **-1**, **+1**, **-10** and **+10** keys or the **rotary control** to adjust the displayed heading until it matches boat's steering compass or a known transit bearing.
- Press and hold **standby** for 2 seconds to exit Seatrial Calibration and save the new compass settings.

#### Align the autopilot heading

- a Coarse adjustment:** If COG is available from GPS, press  to set autopilot heading to COG value, then fine tune manually (see below).
- b Fine adjustment:** If COG is not available (or after setting heading to COG), align autopilot heading manually:

#### ST6001, ST7001, ST6002 & ST7002

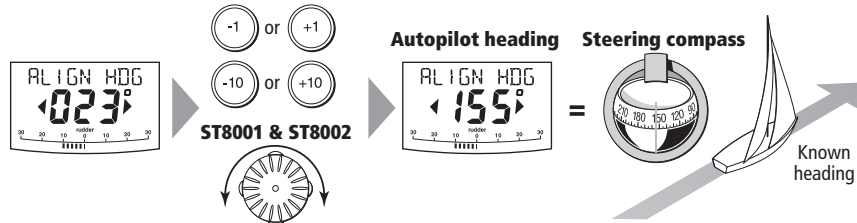

Adjust the autopilot heading so it shows the same value as the boat's steering compass

#### Save changes



- To:
- save deviation correction
  - save heading alignment
  - return to STANDBY mode

D6320-2





## Adjusting the heading alignment

After completing the initial compass calibration, you can make further adjustments to the alignment without having to swing the compass again.

Although the compass calibration removes most of the alignment error, small errors (a few degrees) will probably remain.

Ideally, you should check the heading reading against a number of known headings, plot a deviation curve, and determine the heading alignment value that will give the lowest **average** alignment error. You can then enter this value on the Heading Alignment screen, as described above.

If the average heading error is more than 5°, you should perform the compass deviation correction procedure again, circling more slowly and in more favorable conditions.

## Adjusting SmartPilot steering settings

The next stage of the seatrial is to set key parameters that affect the SmartPilot's steering characteristics.

- **using AutoLearn:** S1G, S2G and S3G systems use AutoLearn – a self-learning calibration feature that automatically adjusts rudder gain, counter rudder and AutoTrim to suit your boat
- **manual set-up:** Non-G systems will require manual adjustment – see *page 34* for instructions.

### AutoLearn



#### WARNING: AutoLearn safety

**The AutoLearn process requires a significant amount of CLEAR SEA SPACE in front of the boat. The SmartPilot will take the boat through a number of zig-zag maneuvers until it has acquired enough data. These actions can result in sudden, sharp turns, especially when the AutoLearn function is run on more maneuverable boats. Press the standby key at any time to cancel the AutoLearn and regain manual control of the boat.**

**Note:** *For optimum AutoLearn results, please ensure that your boat's rudder is aligned correctly. See page 26 for more details.*

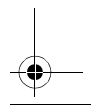
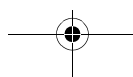
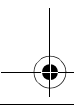
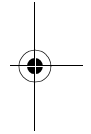
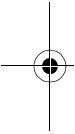

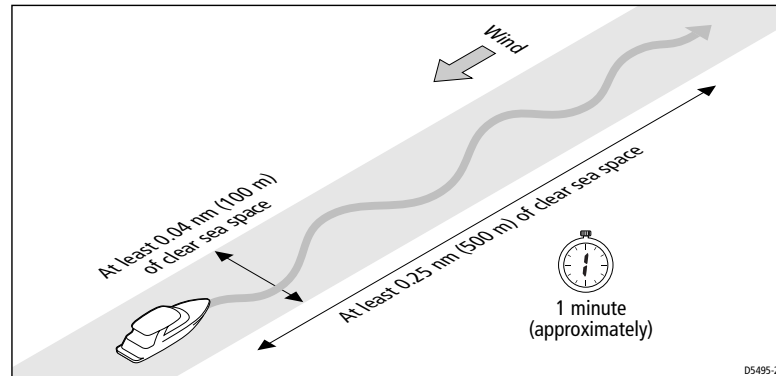

1. Access the AUTOLEARN screen in Seatrial Calibration:
  - i. from Standby mode, press **standby** for 2 seconds, then **disp** twice to see the SEATRIAL CAL screen
  - ii. then press **auto** to enter Seatrial Calibration, and **disp** 4 times until you see the AUTOLEARN page

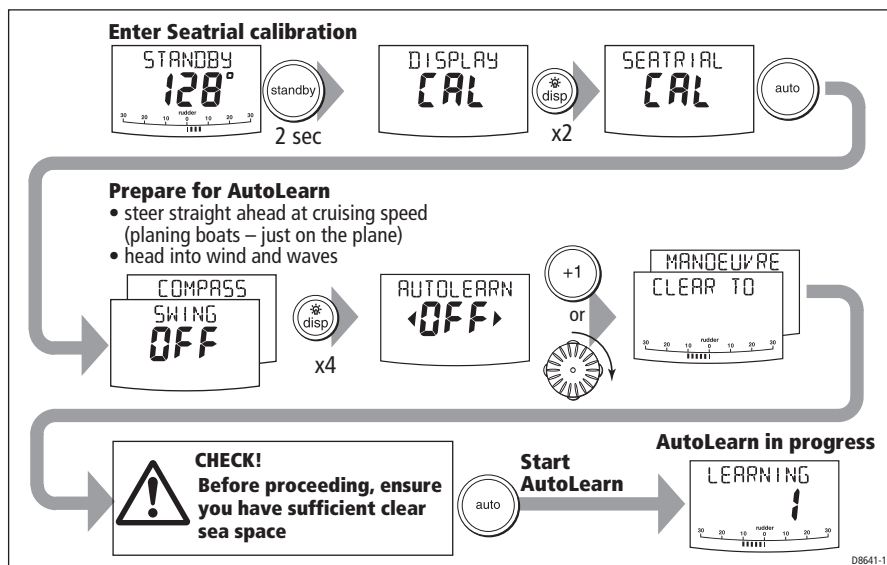

2. Prepare to start the AutoLearn:
  - **power boats:** steer straight ahead (rudder centered). For non-planing boats, set a comfortable cruising speed. For planing boats set the speed so the boat is just planing

- **sail boats:** with the sails down, steer straight ahead (rudder centered) and motor the boat at typical cruising speed
  - if conditions are not calm, head into the wind and waves
3. When you are ready to proceed, press **+1**, or turn the **rotary control** clockwise. (On ST8001 & ST8002 systems, you must also then press **auto**)
  4. The screen will then show the **CLEAR TO MANEUVER** message. If it is safe to continue, press **auto** to start the AutoLearn maneuvers:
    - the boat will start a series of zig-zag turns and the display will show **LEARNING** with a number to indicate the current AutoLearn stage
    - this number will increase as AutoLearn progresses
    - typically, the AutoLearn will be complete within 7 to 27 steps (depending on boat characteristics and sea conditions)

**Note:** *If you need to cancel the AutoLearn, press the **standby** or **disp** key.*

5. When the SmartPilot has finished learning, the controller will beep and will display either **LRN PASS** or **LRN FAIL**:
  - **LRN PASS** = AutoLearn completed successfully
  - **LRN FAIL** = AutoLearn was not successful, so should be repeated. A failure code will also be displayed:
    - 1 = AutoLearn has not been carried out
    - 2 = AutoLearn failed, due to manual interruption
    - 4 = AutoLearn failed, probably due to drive or compass failure
6. Press and hold the **standby** key for two seconds to store the new settings.

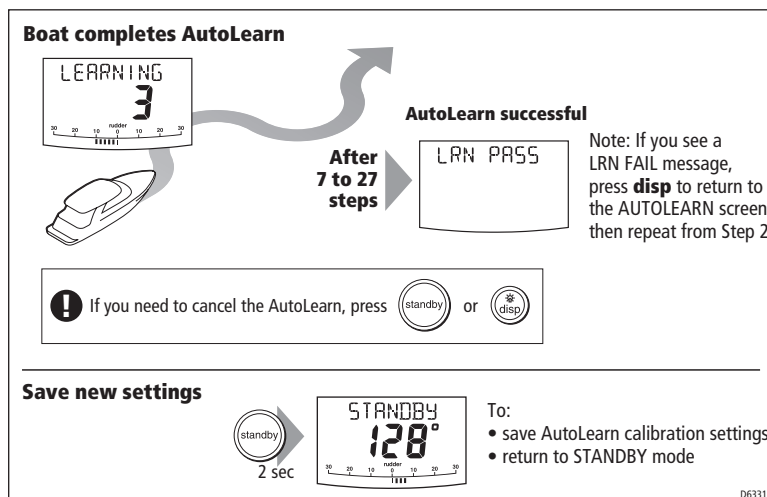

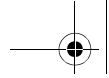

### Your SmartPilot is now fully calibrated and ready for use.

The only additional setting you may need to adjust is the response level (see the appropriate *SmartPilot Operating Guide* for more information).

## Manual set-up: Non-G Systems

If you have a Non-G system you need to manually adjust the rudder gain, counter rudder and AutoTrim settings, based on your observations of the boat's performance under SmartPilot control.

Adjust these settings when motoring your boat at cruising speed. On sail boats, repeat if necessary under sail to optimize the SmartPilot.

### Checking SmartPilot operation

Before manually adjusting any of these settings, familiarize yourself with basic SmartPilot operation:

1. Steer onto a compass heading and hold the course steady.  
If necessary, steer the boat manually for a short time to check how the boat steers.
2. Press **auto** to lock onto the current heading. The SmartPilot should hold a constant heading in calm sea conditions.
3. Use the **-1**, **+1**, **-10** and **+10** keys or the **rotary control** to see how the SmartPilot alters the course to port and starboard.
4. Press **standby** to return to manual steering.

### Response level

The principal method of adjusting the performance of SmartPilot systems is by changing the response level. This is the only user adjustment you should need to make to the SmartPilot on a regular basis. This controls the relationship between the SmartPilot's course keeping accuracy and the amount of helm/drive activity.

Whilst it is not necessary to set the response level at this stage, the testing of other parameters requires the temporary adjustment of response settings.

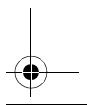
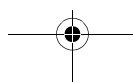
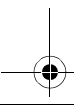
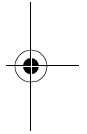
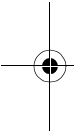

Screen Text	Effect on operation
RESPONSE 1	The SmartPilot will gradually ignore repetitive boat movements and only react to true variations in course. This gives the best compromise between power use and course keeping
RESPONSE 2	This setting provides tighter course keeping but will lead to increased power consumption and drive unit activity
RESPONSE 3	This setting provides the tightest possible course keeping.

To temporarily change the response level:

1. press **-1** and **+1** or **resp** to access the RESPONSE screen
2. use the **-1** or **+1** key or the **up and down arrow** keys to adjust the setting
3. press **disp** to confirm the change

### Adjusting the rudder gain

Boats can vary widely in their response to helm, and by adjusting the rudder gain you can change the SmartPilot's steering characteristics. Rudder gain is a measure of how much helm the SmartPilot applies to correct course errors – higher settings mean more rudder is applied.

Complete the following test to determine whether the rudder gain is set correctly:

1. Set RESPONSE to level 2 (see above)
2. Sail your boat at cruising speed in clear water:
  - you will find it easier to recognize the steering response in calm sea conditions where wave action does not mask steering performance
3. Press **auto** to enter Auto mode, then alter course by 40°:
  - if the rudder gain is adjusted correctly, the 40° course change should result in a crisp turn followed by an overshoot of no more than 5°
  - if the rudder gain setting is too high, the 40° course change will result in a distinct overshoot of more than 5° and there may be a distinct 'S' in the course **(A)**  
Correct this oversteer by **reducing** the rudder gain setting
  - if the rudder gain is too low, the boat's performance will be sluggish – it will take a long time to make the 40° turn and there will be no overshoot **(B)**  
Correct this understeer by **increasing** the rudder gain setting.

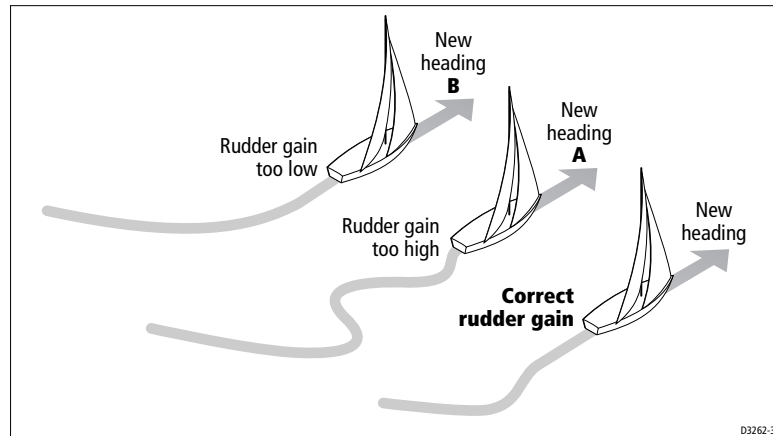

To adjust the rudder gain:

1. Access the **RUDD GAIN** screen in Dealer Calibration.
2. Use the **-1** or **+1** keys or the **rotary control** to adjust the rudder gain.
3. Press and hold **standby** for 2 seconds to save the changes.
4. Press **auto** to check SmartPilot performance in Auto mode.

### Adjusting the counter rudder

If you intend to use **RESPONSE** level 3 (the tightest possible course-keeping) on a Non-G system, you will need to adjust the counter rudder.

Counter rudder is the amount of rudder the SmartPilot applies to try to prevent the boat from yawing off course. Higher counter rudder settings result in more rudder being applied.

To check the counter rudder setting

1. Set **RESPONSE** to level 3 (see *page 35*)
2. Sail your boat at cruising speed in clear water
3. Press **auto** to switch the SmartPilot to Auto mode, then make a 90° course change:
  - when gain and counter rudder are both set correctly, the boat performs a smooth continuous turn with minimal overshoot
  - if the counter rudder is too low, the boat will still overshoot
  - if counter rudder is too high, the boat will 'fight' the turn and make a series of short, sharp turns: this results in a very 'mechanical' feel as the boat changes course



To adjust the counter rudder:

1. Access the **COUNT RUD** screen in Dealer Calibration. (see *page 23*)
2. Use the **-1** or **+1** keys or the **rotary control** to adjust the counter rudder.
3. Press and hold **standby** for 2 seconds to save the changes.
4. Press **auto** to check the SmartPilot performance in Auto mode.

**Your SmartPilot is now calibrated and ready for use.**

The only additional setting you may need to adjust is the response level (see *SmartPilot Operating Guide* for more information).

### Further adjustments (Non-G)

Over time you may need to repeat these adjustments using a range of sea conditions and headings to achieve good overall performance.

You may also need to adjust the AutoTrim setting. AutoTrim determines how quickly the SmartPilot applies 'standing helm' to correct for trim changes (caused, for example, by changes in the wind load on the sails or superstructure, or an imbalance of engines).

Gain experience with your SmartPilot before attempting to adjust the AutoTrim setting. On sail boats you can only evaluate the effect of AutoTrim while under sail.

Increasing the AutoTrim level reduces the time the SmartPilot takes to get back onto the correct course, but makes the boat less stable:

- if the SmartPilot gives unstable course keeping and the boat 'snakes' around the desired course, **decrease** the AutoTrim level
- if the SmartPilot hangs off course for excessive periods of time, **increase** the AutoTrim level

If you need to adjust AutoTrim, go up one level at a time and use the lowest acceptable value. The possible settings range from OFF (no trim correction) to 4 (fastest trim correction). To adjust the AutoTrim:

Access the **AUTOTRIM** screen in Dealer Calibration.

Use the **-1** or **+1** keys or the **rotary control** to adjust the AutoTrim level.

Press and hold **standby** for 2 seconds to save the changes.

Press **auto** to check the SmartPilot performance in Auto mode.

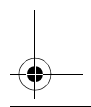
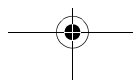
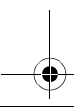
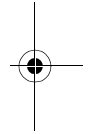
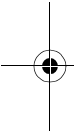

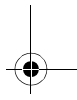
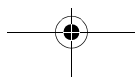
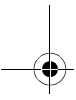
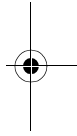
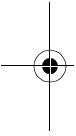
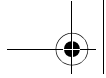





## Chapter 3: Adjusting SmartPilot Settings

This chapter explains all of the calibration settings you can adjust on the SmartPilot. You will have adjusted many of these settings when commissioning the system, and they should not require further adjustment. Complete the procedures described in *Chapter 2* before adjusting any calibration settings.

### 3.1 Calibration basics

#### Calibration groups

The Calibration mode has 4 main calibration groups:

##### **Display Calibration** (DISPLAY CAL)

The items in Display Calibration affect the individual controller. They are stored in the controller and do not affect any other controllers connected through SeaTalk.

You can adjust the Display Calibration settings as often as necessary – for example, to add or change information displayed on data pages.

##### **User Calibration** (USER CAL)

The items in User Calibration vary according to the Vessel Type you have selected in Dealer Calibration.

You will probably need to access User Calibration on a fairly regular basis to adjust SmartPilot settings in response to changing conditions. Details on User Calibration can be found in the *SmartPilot Controller Operation Manual*.

##### **Seatrial Calibration** (SEATRIAL CAL)

The Seatrial Calibration group is specifically designed for use during the initial seatrial (see *page 27* of *Chapter 2* for full details).

You should not need to access Seatrial Calibration during normal operation.

##### **Dealer Calibration** (DEALER CAL)

The Dealer Calibration group includes items that have a significant impact on operation and can affect your boat's safety.

After you have completed the initial installation and seatrial, you should not normally need to alter the Dealer Calibration values. The items in Dealer Calibration vary according to the Vessel Type you have selected.

## Accessing the Calibration modes

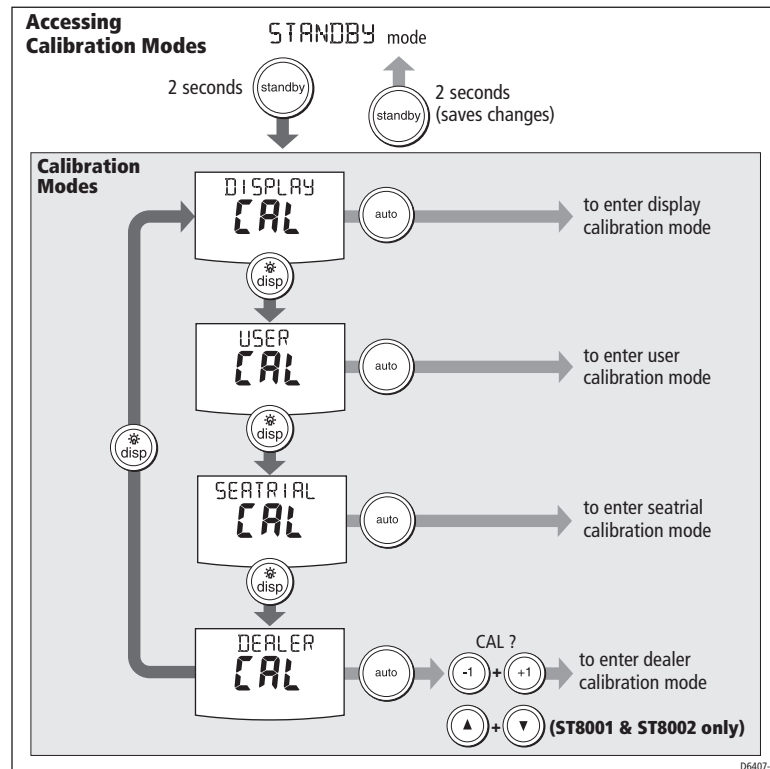

You can only access Calibration mode from Standby mode:

1. With the SmartPilot in Standby mode, press and hold the **standby** key for 2 seconds. The display will change to show DISPLAY CAL.
2. Press the **disp** key to scroll through the 4 calibration groupings:
  - Display Calibration (DISPLAY CAL)
  - User Calibration (USER CAL)
  - Seatrial Calibration (SEATRIAL CAL)
  - Dealer Calibration (DEALER CAL)

**Note:** You can go backwards through the groups by pressing and holding the **disp** key for one second.

3. When you reach the Calibration group you want to access, press **auto** to enter that group:  
To prevent accidental access, we have made entry to Dealer Calibration more

difficult than the other groups. After pressing **auto**, the display will show **CAL ?**. When you see this, press the **-1** and **+1** keys (or the **up** and **down arrow** keys) together to enter Dealer Calibration.

4. When you have entered one of the Calibration groupings, press **disp** key to scroll down through the items within that grouping:

**Note:** You can go backwards through the list by pressing and holding the **disp** key for one second.

5. When you reach an item you wish to adjust, use the **-1**, **+1**, **-10** and **+10** keys or the **rotary control** (as appropriate) to change the value.
6. If you then want to adjust settings in another Calibration group, press **standby** and then repeat steps 2 to 5 as necessary.
7. When you have made all the changes you want to make, press and hold **standby** for two seconds to exit Calibration mode and save changes.

## 3.2 Display Calibration

Display Calibration allows you to select the type of bar graph and heading shown on the SmartPilot display, and set the information to be shown on the data pages.

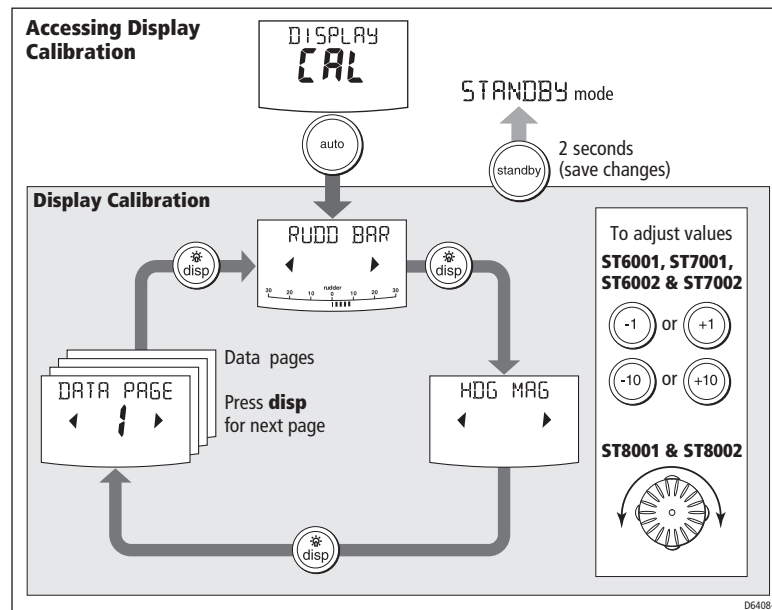

## Display Calibration screens

### Display bar selection

This screen allows you to select what information is displayed at the bottom of the SmartPilot display.

#### Options

RUDD BAR (Default)	Rudder position bar. It uses the bar graph to show the true rudder angle. Requires rudder position sensor for accurate rudder information.
STEER BAR	This setting uses the bar graph to indicate different information in different operating modes: STANDBY: rudder position bar AUTO: heading error bar (in 2° increments) TRACK: cross track error (XTE) bar (in 0.02 nm increments) WIND VANE: wind angle error bar (in 2° increments)
BAR OFF	No bar is displayed

### Heading selection

This screen allows you to display any heading as either a magnetic or true value. During normal SmartPilot operation the screen will indicate MAG for magnetic headings and TRUE for true headings.

#### Options

HDG MAG	Magnetic heading
HDG TRUE	True heading.

### Pop-up pilot time-out (ST7001, ST7002, ST8001 & ST8002 only)

During normal operation, you can set the controller so it has a data page as the main display (*see SmartPilot Operating Guide*). Whenever there is a change in the autopilot mode, a screen will 'pop-up'. After a short period, the display reverts to the selected data page. The default pop-up time is 5 seconds. You can use this setting to adjust the pop-up pilot display time-out.

Screen text	Options
POPUP TIMEOUT	1 seconds to 10 seconds; Default = 5 seconds

## Data pages

SmartPilot controllers have 15 user-configurable pages. The following screens allow you to modify the settings for the data pages. These define which SeaTalk/NMEA data pages will be available during normal operation (see *SmartPilot Operating Guide*). Each data page setup screen initially shows the title DATA PAGE and the page number. After 1 second, the text changes to the title of the data set for that page.

The default settings are:

Data Page	Default Setting
1	XTE (Cross Track Error)
2	BTW (Bearing to Waypoint) - see Note below
3	DTW (Distance to Waypoint) - see Note below
4	RESPONSE
Remaining pages	NOT USED (These pages are not displayed when you scroll through the data pages during normal operation)

**Note:** *It is good practice to keep the BTW and DTW pages for display. If your SmartPilot receives a man overboard (MOB) message, these data pages will show the bearing and distance to the MOB location.*

To change the data displayed on a data page:

1. Press **disp** to move to the appropriate data page setup screen.
2. Use the **-1** and **+1** keys or the **rotary control** to scroll forwards or backwards through the available data pages (see following table).
3. Then press **disp** to move to the next data page you want to change, or press and hold **standby** for 2 seconds to save changes.

Available Data Pages	Displayed as
Speed Knots	SPEED KTS
Log	LOG XXXX.X
Trip	TRIP XXX.X
Average Speed, Knots	AV. SPD KTS
Wind Direction	e.g. WIND PORT
Wind Speed	WIND KTS

Available Data Pages	Displayed as
Depth Metres	DEPTH M - see Note below
Depth Feet	DEPTH FT - see Note below
Depth Fathoms	DEPTH FA - see Note below
Heading	HEADING
Water Temperature, Degrees C	WATER °C - see Note below
Water Temperature, Degrees F	WATER °F - see Note below
Course Over Ground	COG
Speed Over Ground, Knots	SOG KTS
Cross Track Error	XTE
Distance to Waypoint	DTW
Bearing to Waypoint	BTW
Rudder Gain	RUDD GAIN
Response	RESPONSE
Watch	WATCH - used to control the Watch timer
Universal Time Coordinated	UTC
NOT USED	Page not displayed (Any data page set to NOT USED is not displayed when you scroll through the data pages during normal operation)

**Note:** There are 3 depth pages (meters, feet and fathoms) and 2 water temperature pages (°C and °F). The SmartPilot will display the depth data or water temperature in the units defined by data page you select.

### 3.3 User Calibration

The User Calibration group includes settings that you may need to adjust on a regular basis due to changing conditions. The User Calibration options (AUTO TACK, GYBE STOP, WIND TYPE, WIND TRIM and RESPONSE) are also available via Dealer Calibration (see *page 45*). The *SmartPilot Operating Guide* contains specific User Calibration instructions.

### 3.4 Seatrial Calibration

The Seatrial Calibration group has been designed specifically for use during the initial seatrial when commissioning your SmartPilot. Refer to *Chapter 2: SmartPilot Commissioning* for full details.

**CAUTION:**

**You should not need to access Seatrial Calibration to adjust settings during normal operation.**

### 3.5 Dealer Calibration

The Dealer Calibration group includes items that have a significant impact on SmartPilot operation and can affect your boat's safety. Once you have commissioned the SmartPilot, you should not normally need to alter the Dealer Calibration values.

#### Accessing Dealer Calibration

To prevent accidental access, we have made entry to Dealer Calibration more difficult than the other calibration groups:

To access Dealer Calibration:

ST6001 & ST6002 Controllers	ST7001, ST7002, ST8001 & ST8002 Controllers
<ul style="list-style-type: none"> <li>press and hold the <b>standby</b> key for two seconds to enter the Calibration mode</li> <li>when the screen shows DISPLAY CAL, press the <b>disp</b> key until you see the DEALER CAL screen</li> <li>press the <b>auto</b> key: the display will change to CAL?</li> <li>press <b>-1</b> and <b>+1</b> together to enter Dealer Calibration mode</li> </ul>	<ul style="list-style-type: none"> <li>press and hold the <b>standby</b> key for two seconds to enter the Calibration mode</li> <li>when the screen shows DISPLAY CAL, press the <b>disp, up or down arrow key</b> until you see the DEALER CAL screen</li> <li>press the <b>auto</b> key: the display will change to CAL?</li> <li>press <b>up and down arrow keys</b> together to enter Dealer Calibration mode</li> </ul>

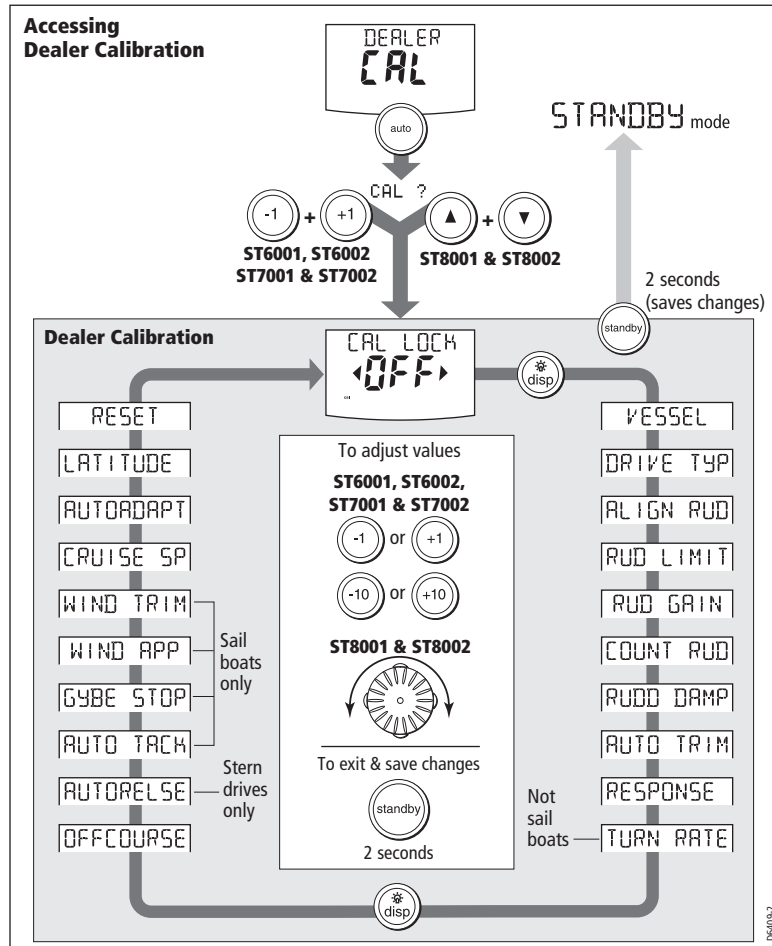



## Dealer Calibration screens and settings

The items in Dealer Calibration vary according to the vessel type you have selected. See the table on *page 57* for default values.

### SeaTrial Calibration lock

This screen controls whether it is possible to access Seatrial Calibration.

#### Options

CAL LOCK OFF	Calibration lock off – Seatrial calibration can be accessed (default)
CAL LOCK ON	Calibration lock on – Seatrial calibration cannot be accessed

### Vessel type

Vessel type should be set when commissioning the SmartPilot (see *page 23*).

#### Options

DISPLACE	Power-driven boats which do not plane (Typically below 15 kts top speed)
SEMI DISPLACE	Faster power-driven boats which do not plane (Typically 15-20 kts top speed)
PLANING	Planing boats with inboard engine(s) and shaft drives (NOT boats with outdrives)
STERN DRV	Boats with outdrives or outboard engines, including Mercury Verado and Volvo Penta IPS.
WORK BOAT	Commercial tugs, fishing vessels, etc
SAIL BOAT	Sailing boat

- Notes:**
- (1) *When you select the vessel type, the SmartPilot will set appropriate defaults for several other calibration settings. Refer to the table on page 57 for default values.*
  - (2) *The vessel type options will normally give optimum performance for typical vessels of each type. However, you may find you can improve the performance of your vessel by selecting an option for a different vessel type.*

## Drive type

The drive type setting controls how the SmartPilot drives the steering system. The drive type should be set when commissioning the SmartPilot (see *page 25*).

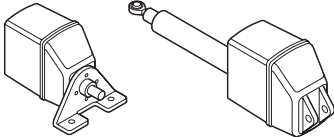
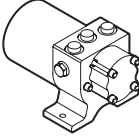
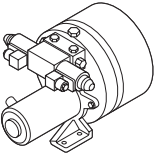
Drive	Drive Type Setting
 <p style="text-align: right; margin-right: 10px;">D6404-1</p>	<p><b>Drive Type 3</b></p> <ul style="list-style-type: none"> <li>• Linear</li> <li>• Rotary</li> </ul> <p>Typically found on yachts</p> <ul style="list-style-type: none"> <li>• I/O (stern)</li> </ul> <p>Found on Powerboats</p>
 <p style="text-align: right; margin-right: 10px;">D6405-1</p>	<p><b>Drive Type 4</b></p> <ul style="list-style-type: none"> <li>• Hydraulic reversing pump</li> </ul> <p>Used on yachts and powerboats with hydraulic steering</p>
 <p style="text-align: right; margin-right: 10px;">D6406-1</p>	<p><b>Drive Type 5</b></p> <ul style="list-style-type: none"> <li>• Constant running hydraulic pumps. Controlled by solenoid valves</li> </ul> <p>Found on light commercial and larger boats (S2 and S3 systems only)</p>

## Align rudder

Use this setting to calibrate the rudder bar display. This is usually set as part of the commissioning process (see *page 26*). This screen also appears in the Seatrial Calibration grouping.

Screen Text	Range
ALIGN RUDDER	S1 Systems: -9° to +9° in 1° steps S2 & S3 Systems: -7° to +7° in 1° steps

### Rudder limit

Use the rudder limit screen to set the limits of the rudder control just inside the mechanical end stops. This will avoid putting the steering system under unnecessary load. You should adjust this setting when commissioning the SmartPilot (see *page 26*).

Screen Text	Range
RUDDER LIMIT	10° to 40° in 1° steps

### Rudder gain

Rudder gain is a measure of how much helm the SmartPilot will apply to correct course errors. The higher the setting the more rudder will be applied.

The default rudder gain is set during the initial seatrial:

- S1G, S2G and S3G systems will adjust the rudder gain automatically during AutoLearn (see *page 31*)
- Non-G systems will require manual adjustment of rudder gain (see *page 35*)

You can make temporary changes to this rudder gain value during normal operation (see *SmartPilot Operating Guide*).

Screen Text	Range
RUDD GAIN	1 to 9

### Counter rudder

Counter rudder is the amount of rudder the SmartPilot applies to try to prevent the boat from yawing off course. Higher counter rudder settings result in more rudder being applied.

The default counter rudder gain is set during the initial seatrial:

- S1G, S2G and S3G systems will adjust the counter rudder setting automatically during the AutoLearn (see *page 31*)
- Non-G systems will require manual adjustment of counter rudder (see *page 36*)

Screen Text	Range
COUNT RUD	1 to 9

## Rudder damping

Adjust the rudder damping value if the SmartPilot 'hunts' when trying to position the rudder. Increasing the rudder damping value reduces hunting. Increase the damping one level at a time until the autopilot stops hunting, and always use the lowest acceptable value

Screen Text	Range
RUDD DAMP	1 to 9

## AutoTrim

The AutoTrim setting determines the rate at which the SmartPilot applies 'standing helm' to correct for trim changes caused by varying wind loads on the sails or superstructure.

The default AutoTrim is set during commissioning:

- S1G, S2G and S3G systems will adjust the AutoTrim setting automatically during the AutoLearn (see *page 31*)
- Non-G systems will require manual adjustment of AutoTrim (see *page 37*) after the initial seatrial

If you need to change the setting, increase the AutoTrim one level at a time and use the **lowest** acceptable value:

- decrease the AutoTrim level if the SmartPilot gives unstable course keeping or excessive drive activity with a change in the heel angle
- increase the AutoTrim level if the SmartPilot reacts slowly to a heading change due to a change in the heel angle
- if the AutoTrim level is too high, the boat will be less stable and snake around the desired course

**Note:** S1G, S2G and S3G systems have a 'FastTrim' feature within AutoTrim. Select AUTO TRIM OFF to turn off FastTrim as well as AutoTrim.

Setting	Effect
AUTO TRIM OFF	No trim correction
AUTO TRIM 1	Slow trim correction
AUTO TRIM 2	Medium trim correction
AUTO TRIM 3	Rapid trim correction
AUTO TRIM 4	Very rapid trim correction

## Response level

This sets the default SmartPilot response level setting. The response level controls the relationship between course keeping accuracy and the amount of helm/drive activity. You can make temporary changes to response during normal operation (see *SmartPilot Operating Guide*).

### S1G, S2G and S3G Systems

Screen Text	Options
RESPONSE	Range = 1 to 9 <b>level 1</b> minimizes the amount of pilot activity. This conserves power, but may compromise short-term course-keeping accuracy <b>levels 4 to 6</b> should give good course keeping with crisp, well controlled turns under normal operating conditions <b>level 9</b> gives the tightest course keeping and greatest rudder activity (and power consumption). This can lead to a rough passage in open waters as the SmartPilot may 'fight' the sea.

### Non-G systems

Screen Text	Options
RESPONSE 1	AutoSeastate on (Automatic deadband) The SmartPilot will gradually ignore repetitive boat movements and only react to true variations in course. This provides the best compromise between power consumption and course keeping accuracy
RESPONSE 2	AutoSeastate off (minimum deadband) This setting provides tighter course keeping but will lead to increased power consumption and drive unit activity
RESPONSE 3	AutoSeastate off + counter rudder yaw damping This setting provides the tightest possible course keeping by introducing counter rudder yaw damping

## Turn rate limit

**Note:** *Not available if vessel type = SAIL BOAT.*

This limits your boat's rate of turn under SmartPilot control.

Screen Text	Range
TURN RATE	1° to 30° per second in 1° steps

## Off course warning angle

This screen determines the angle used by the OFF COURSE warning (see *SmartPilot Operating Guide*). The OFF COURSE warning operates if the pilot strays off course by more than the specified angle for more than 20 seconds.

Screen Text	Range
OFF COURSE	15° to 40° in 1° steps

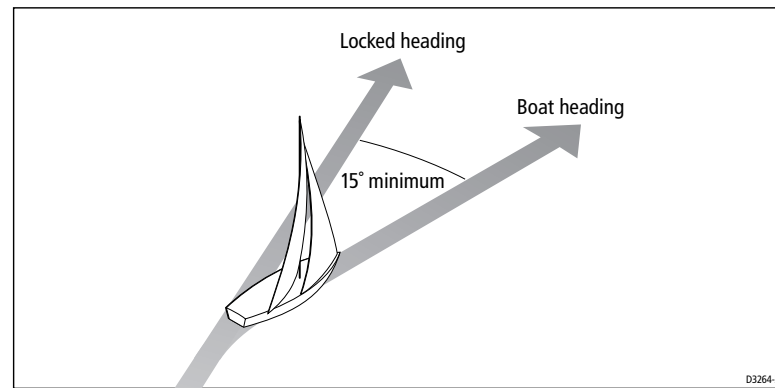

## Joystick mode (PWR STEER)

If you have a joystick connected to your Smartpilot, use this screen to select the required joystick mode of operation. For detailed operating information, refer to the guide supplied with the joystick

Options	
OFF	Joystick off
1	1 = Proportional power steer Proportional power steer applies rudder in proportion to joystick movement – the further the joystick is held over, the greater the applied rudder.
2	2 = Bang-bang power steer Bang-bang power steer applies continuous rudder in the direction of the lever movement – to improve control, the speed of rudder movement changes with the angle of the lever. For maximum speed, push the lever hardover. If you return the lever to the center position, the rudder will remain in its current position.

### AutoRelease (I/O drives only)

Only available if vessel type = STERNDRV.

AutoRelease provides emergency manual over-ride in situations when you need to avoid an obstacle at the last moment. If the vessel type is set to STERN DRV (I/O or stern drive), you will see the AutoRelease screen (AUTO RELSE) set to ON as a default.

Screen Text	Range
AUTO RELEASE	ON = AutoRelease on (default) OFF = AutoRelease off

### AutoTack angle

**Note:** Only available if vessel type = SAIL BOAT.

The AutoTack angle is the angle through which the boat will turn when you select an automatic tack.

Screen Text	Options
AUTO TACK	40° to 125° in 1° steps

### Gybe inhibit

**Note:** Only available if vessel type = SAIL BOAT.

With gybe inhibit on:

- you will be able to perform an AutoTack into the wind
- to prevent accidental gybes, the SmartPilot will prevent the boat from performing an AutoTack away from the wind

With gybe inhibit off, you can perform an AutoTack into or away from the wind.

Screen Text	Options
GYBE STOP	On (Default) = Gybe inhibit on (gybes prevented) OFF = Gybe inhibit off (gybes permitted)



### Wind selection

**Note:** *Only available if vessel type = SAIL BOAT and appropriate wind data is available.*

This screen determines whether the boat steers to apparent or true wind in Wind Vane mode.

---

#### Options

WIND APP (Default)	SmartPilot steers to apparent wind angle
WIND TRUE	SmartPilot steers to true wind angle

---

### WindTrim (wind response)

**Note:** *Only available if vessel type = SAIL BOAT.*

WindTrim controls how quickly the SmartPilot responds to changes in the wind direction. Higher wind trim settings will result in a system that is more responsive to wind changes.

Screen Text	Options
WIND TRIM	Range = 1 to 9 Lower values (1 to 3) = SmartPilot responds to longer term wind changes (less system activity) Typical values = 4 to 6 Higher values (7 to 9) = SmartPilot responds to shorter term wind changes (more system activity)

---

### Cruise speed

Set the cruise speed to the boat's typical cruising speed. If both the boat's speed through the water and speed over ground are unavailable via SeaTalk or NMEA, the SmartPilot will use this default cruise speed when calculating course changes.

Screen Text	Range
CRUISE SP	4 to 60 knots

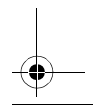
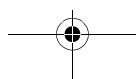
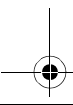
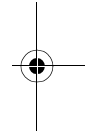
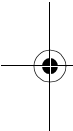



## AutoAdapt

The AutoAdapt feature allows the SmartPilot to compensate for heading errors, caused by the increasing dip of the earth's magnetic field, at higher latitudes. This increased dip has the effect of amplifying rudder response on northerly headings in the northern hemisphere, and on southerly headings in the southern hemisphere.

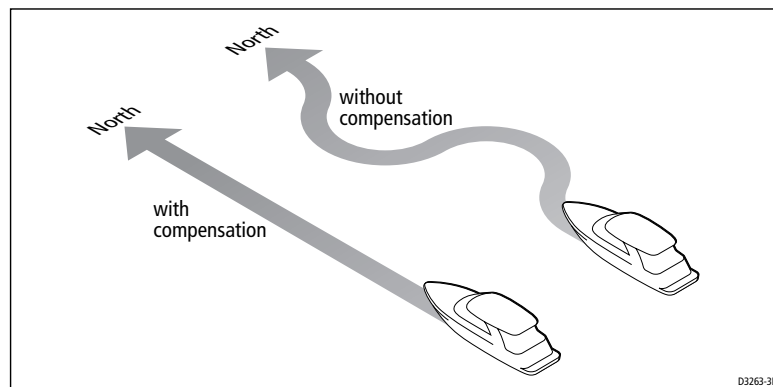

### Options

AUTOADAPT OFF	AutoAdapt off
AUTOADAPT nth	AutoAdapt compensation on – Northern hemisphere (default)
AUTOADAPT Sth	AutoAdapt compensation on – Southern hemisphere

If you set AUTOADAPT to nth or Sth, you then need to enter your current latitude in the next screen (LATITUDE). If you have a GPS connected, the SmartPilot will take latitude information from the GPS.

### Latitude

The SmartPilot only displays this screen if you have set AUTOADAPT to nth or Sth. Use the **-1,+1,-10** and **+10** keys or the **rotary control** to set the value to your boat's current latitude, to the nearest degree.

If valid latitude data is available via SeaTalk or NMEA, the SmartPilot will use this data instead of the calibration value.

Screen Text	Range
LATITUDE	0° to 80° in 1° steps

## System reset



### **WARNING: Losing settings at system reset**

**Do NOT use this feature unless advised to do so by a Raymarine dealer. If you complete a reset you will lose ALL SmartPilot calibration settings. You will then need to repeat the SmartPilot commissioning process.**

Selecting System reset will reset all of the calibration values:

- all of the settings in User Calibration, Seatrial Calibration and Dealer Calibration will return to the factory default values
- the settings in Display Calibration will not change, as these are stored in each individual controller

To reset the system:

1. Select the System reset (RESET) screen in Dealer Calibration.
2. Press the **+1** key (on ST8001 & ST8002, turn the **rotary control clockwise** and press **auto**)
3. The screen will then show an ARE YOU SURE message:
  - press the **+1** key again to select 'YES' and reset the SmartPilot (on ST8001 & ST8002, turn the **rotary control clockwise** and press **auto**)
  - alternatively, press the **disp** key to cancel
4. You will then see the CAL LOCK screen:
  - press **standby** for 2 seconds to save the new default settings, then turn the SmartPilot computer power off and back on



## Dealer Calibration options

The following Dealer calibration options are available for Displacement, Semi-Displacement, Planing, Stern Drive (I/O), Work Boat & Sail Boat vessel types.

Parameter	Options	Your settings
Calibration Lock	OFF, ON	
Vessel Type	DISPLACE, SEMI DISPLACE, PLANING, STERN DRV, WORK BOAT, SAIL BOAT	
Drive Type	3, 4, 5 (S2/S3 only)	
Rudder Alignment	S1: -9 to +9 S2 & S3: -7 to +7	
Rudder Limit	10 to 40	
Rudder Gain	1 to 9	
Counter Rudder	1 to 9	
Rudder Damping	1 to 9	
AutoTrim	0 to 4	
Response: Gyro Non-G	1 to 9 1 to 3	
Turn Rate Limit	1 to 30	
Off Course Angle	15 to 40	
Power Steer (Joystick)	OFF, 1, 2	
AutoRelease	OFF, ON	
AutoTack Angle	40 to 125	
Gybe Inhibit	OFF, ON	
Wind Type	APPARENT, TRUE	
Wind Trim	1 to 9	
Cruise Speed	4 to 60	
AutoAdapt	OFF, nth, Sth	
Latitude	0 to 80	
Variation	-30 to +30	
Autopilot Reset	OFF, ON	

## Chapter 4: Fault Finding & Maintenance

All Raymarine products are designed to provide many years of trouble-free operation. We also put them through comprehensive testing and quality assurance procedures before shipping.

This chapter provides information about identifying problems, interpreting alarm messages, maintaining your SmartPilot and obtaining product support.

If a fault occurs with your SmartPilot, use the fault finding tables in this section to help identify the problem and provide a solution. If you cannot resolve the problem yourself, refer to the product support information.

### 4.1 Fault finding

SYMPTOM	POSSIBLE CAUSE and SOLUTION
Display is blank	No power – check the power and SeaTalk fuses on the computer, then check main fuse/circuit breaker.
Data page display shows stationary dashes	The control unit is not receiving necessary data from other instruments – check cabling.
Display shows rotating dashes	Compass calibration in progress
Displayed compass heading does not agree with the boat's compass	You have not calibrated the compass. Carry out the deviation and alignment procedures
No display bar on the display	Rudder bar switched off in Display Calibration – select RUDD BAR or STEER BAR
Rudder bar display moves in opposite direction to rudder	Reverse the red and green rudder position sensor connections at the SmartPilot computer
Boat turns slowly and takes a long time to come onto course	Rudder gain too low. Complete AutoLearn or increase gain setting.
Boat overshoots when turning onto a new course	Rudder gain too high. Complete AutoLearn or decrease gain setting.
<b>The SmartPilot 'hunts' when trying to position the rudder</b>	Adjust the RUDD DAMP setting (see <i>page 50</i> ). Increase the damping one level at a time until the autopilot stops hunting, and always use the lowest acceptable value
You cannot enter Seatrial Calibration	Seatrial calibration lock is on – turn off the calibration protection feature in Dealer Calibration

SYMPTOM	POSSIBLE CAUSE and SOLUTION
The SmartPilot appears to be unstable on Northerly headings in the Northern hemisphere (or Southerly headings in the Southern hemisphere)	Northerly/Southerly heading correction (AutoAdapt) is not set up (see <i>page 55</i> ). [Does not apply to S1G, S2G and S3G systems.]
The SmartPilot will not 'talk' to other SeaTalk instruments	Cabling problem – make sure all the cables are connected properly.
Position information not received	Navigator not transmitting the correct position data. Check navigator and cabling to the SmartPilot
Non-Raymarine 24V autopilots clutch slipping	Check that the clutch fuse is in the correct position. E.g. 24 V position for 24 V clutches.
When holding a constant course in STANDBY mode, the heading continuously changes	The Autopilot is connected to a Raymarine Pathfinder unit with the "Bridge NMEA Heading" option switched on. Disable this feature on the Pathfinder unit.

### SmartPilot alarm messages

When the SmartPilot detects a fault or failure on the system, it will activate one of the alarm messages listed in the following table.

- Unless otherwise stated, you should respond to the alarm by pressing **standby** to clear the alarm and return to manual control, before you attempt to resolve the problem.
- In some situations, the SmartPilot will raise more than one alarm. When you have dealt with the first alarm, it will display the next alarm.

ALARM MESSAGE	POSSIBLE CAUSE and SOLUTION
AUTO RELEASE	Possible fault with rudder position sensor – check connections. OR Stern (I/O) drives only – you have taken manual control of steering with AutoRelease on. The alarm cancels automatically after 10 seconds.
CURRENT LIMIT	Serious drive failure – the drive is taking too much current due to short-circuit or jamming. Check the drive unit.

<b>ALARM MESSAGE</b>	<b>POSSIBLE CAUSE and SOLUTION</b>
<b>DRIVESTOP</b>	The autopilot is unable to turn the rudder (this occurs if the weather load on helm is too high, or if the rudder position sensor has passed beyond the preset rudder limits or rudder end-stops). Check drive and rudder position sensor. Check the drive wiring is correctly connected.
<b>LOW BATT</b>	Supply voltage has dropped below acceptable limits. To respond to a Low Battery alarm: <ul style="list-style-type: none"> <li>• press standby to clear the alarm and return to hand steering</li> <li>• start the engine to recharge the battery</li> </ul>
<b>LRN FAIL 1, 2 or 4</b>	AutoLearn not completed successfully. Failure codes: 1 = AutoLearn has not been carried out (default setting) 2 = AutoLearn failed, usually due to manual interruption 4 = AutoLearn failed, probably due to drive or compass failure Repeat the AutoLearn procedure.
<b>MOT POW SWAPPED</b>	Motor cables are connected to power terminals (and power cables are connected to motor terminals) at the computer. Turn off power and swap over connections.
<b>NO DATA</b>	Caused by any of the following situations: <ul style="list-style-type: none"> <li>• the compass is not connected</li> <li>• the autopilot is in Wind Vane mode and it has not received wind angle data for 30 seconds</li> <li>• the autopilot is in Track mode and: <ul style="list-style-type: none"> <li>• the autopilot is not receiving SeaTalk navigation data, or</li> <li>• the position sensor is receiving a low strength signal – this will clear when the signal improves</li> </ul> </li> </ul> Check the connections to the compass and/or wind instrument and/or navigator. Note: The autopilot stops adjusting the heading as soon as it loses data.
<b>NO PILOT</b>	The controller is not receiving data from the SmartPilot computer. Check connections and check the SmartPilot computer is switched on.
<b>RG FAIL</b>	GyroPlus yaw sensor has failed: <ul style="list-style-type: none"> <li>• If you have a S1G, S2G and S3G system with internal GyroPlus sensor – call a Raymarine service agent.</li> </ul> If you have a Non-G computers with external GyroPlus yaw sensor – check the sensor and connections, then call a Raymarine service agent.



<b>ALARM MESSAGE</b>	<b>POSSIBLE CAUSE and SOLUTION</b>
SEATALK and FAIL 1 or 2	SeaTalk data problem on one of the SeaTalk lines – check connections.
STLK FAIL	The control unit cannot transmit data to the SeaTalk system. Make sure all SeaTalk cables are connected properly.

## 4.2 Maintenance

All Raymarine products are designed to provide many years of trouble-free operation. We also put them through comprehensive testing and quality assurance procedures before shipping.

### EMC, servicing and safety guidelines

- Raymarine equipment should be serviced only by authorized Raymarine service technicians. They will ensure that service procedures and replacement parts used will not affect performance. There are no user serviceable parts in any Raymarine product.
- Some products generate high voltages: never handle the cables/connectors when power is being supplied to the equipment.
- When powered up, all electrical equipment produces electromagnetic fields. These can cause adjacent pieces of electrical equipment to interact with one another, with a consequent adverse effect on operation. In order to minimize these effects and enable you to get the best possible performance from your Raymarine equipment, guidelines are given in the installation instructions, to enable you to ensure minimum interaction between different items of equipment, i.e. ensure optimum Electromagnetic Compatibility (EMC).
- Always report EMC-related problems to your nearest Raymarine dealer. We use such information to improve our quality standards.
- In some installations, it may not be possible to prevent the equipment from being affected by external influences. In general this will not damage the equipment but it can lead to spurious resetting action, or momentarily may result in faulty operation.

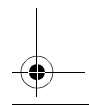
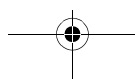
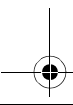
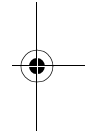
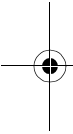



## Product support

Raymarine provides a comprehensive customer support service, on the world wide web and by telephone help line. Please use either of these facilities if you are unable to rectify a problem.

### World wide web

Please visit the Customer Support area of our web site at:  
[www.raymarine.com](http://www.raymarine.com)

As well as providing a comprehensive Frequently Asked Questions section and servicing information, the web site gives e-mail access to the Raymarine Technical Support Department and a details of the locations of Raymarine agents, worldwide.

### Telephone help line

If you do not have access to the world wide web, please call our help line.

**In the USA**, call:

- +1 800 539 5539, extension 2444 or
- +1 603 881 5200 extension 2444

**In the UK, Europe the Middle East or the Far East**, call:

- +44 (0) 23 9271 4713 (voice)
- +44 (0) 23 9266 1228 (fax)

### Help us to help you

When requesting service, please quote the following product information:

- Equipment type.
- Model number.
- Serial number.
- Software issue number.

Refer to the appropriate SmartPilot Operating guide for details of how to obtain the software issue number.

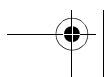
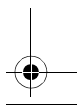
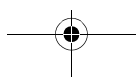
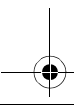
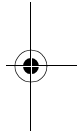
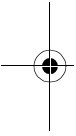
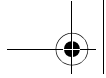

## SmartPilot Specifications

### SmartPilot computer specifications

Nominal supply voltage:	
S1/S1G	12 V DC (fuse protected at 15A)
S2/S2G	12 V DC (fuse protected at 30 A)
S3/S3G	12 V or 24 V DC (fuse protected at 40 A)
Operating voltage range:	
S1/S1G/S2/S2G	10 V to 16 V DC
S3/S3G	10 V to 32 V DC
Power consumption (standby)	
S1 Systems	200 mA
S2 & S3 Systems	300 mA
GyroPlus yaw sensor:	
S1G, S2G and S3G: internal GyroPlus fitted onto circuit board	
Non-G: option of external GyroPlus or dealer-fit internal GyroPlus	
Environmental conditions:	
operating temperature	-10°C to 55°C (14°F to 131°F)
non-operating temperature	-20°C to 70°C (-4°F to 158°F)
relative humidity limit	80%
water protection	drip resistant when mounted vertically
Storage conditions when packed:	
temperature range	-5°C to 50°C (23°F to 122°F)
relative humidity limit	75%
Dimensions:	
(width, height, depth)	
S1 Systems	237 mm (9 <sup>5</sup> / <sub>16</sub> in), 170 mm (6 <sup>11</sup> / <sub>16</sub> in), 55 mm (9 <sup>5</sup> / <sub>16</sub> in),
S2 & S3 Systems	307 mm (12.1 in), 195 mm (7.7 in), 70 mm (2.8 in)
Weight	
S1 Systems	535 g (1 lb 2.8 oz)
S2 & S3 Systems	2.1 kg (4 lb 7.5 oz)
Inputs	
S1 Systems	fluxgate compass, external GyroPlus yaw sensor, rudder position sensor, NMEA 0183 v2.3, SeaTalk (x2), power
S2 & S3 Systems	fluxgate compass, external GyroPlus yaw sensor, rudder position sensor, NMEA 0183 v2.3 (x2), SeaTalk (x2), off switch, power, drive solenoid return

---

**SmartPilot computer specifications**

---

## Outputs

S1 Systems	NMEA 0183 v2.3, SeaTalk (x2), drive motor, drive clutch
S2 & S3 Systems	NMEA 0183 v2.3 (x2), SeaTalk (x2), drive motor, drive clutch

---

## Raymarine drive compatibility:

S1/S1G	all Type 1 12 V drives/pumps (excluding CR pump)
S2/S2G	all Type 1 12 V and Type CR1 12V drives/pumps
S3/S3G	all Type 1, Type 2 and Type 3 drives/pumps (drive voltage must match boat's supply voltage)

---

## Drive motor output:

S1/S1G	continuous 5 A at 12 V
S2/S2G	continuous 18 A at 12 V
S3/S3G	continuous 30 A at supply voltage

---

## Drive clutch output:

S1/S1G	1.5A at 12 V
S2/S2G	4 A at 12 V (fuse protected at 4 A)
S3/S3G	4 A at 12/24 V selectable (fuse protected at 4 A)

---

Drive solenoid return input  
(S2/S3 only) 5 A at supply voltage

---

## SeaTalk output

S1 Systems	2A at 12 V (fuse protected at 2A)
S2 & S3 Systems	5 A at 12 V (fuse protected at 5 A)

---

NMEA 0183 v2.3 inputs/out-puts See *page 13* for information on NMEA 0183 received/transmitted

---

## NMEA fast heading output

(HDM)	
S1 Systems	5 Hz 0.1° resolution
S2 & S3 Systems	10 Hz 0.1° resolution from NMEA 1

---

## Fuses

Standard automotive blade fuses to protect:	
Power Terminals	S1: 15 A, S2: 30 A S3: 40 A
SeaTalk Terminals	S1 systems: 2A, S2 & S3 systems: 5 A
Drive clutch (S2/S3 only)	4 A

---

CE approvals - conforms to: 89/336/EC (EMC), EN60945:1997

---

**WARNING: Potential ignition source**

**Contains a possible source of ignition - NOT protected for use in engine compartments.**

## Glossary

Term	Meaning
AST (Advanced Steering Technology)	AST (Advanced Steering Technology) is Raymarine's unique advanced steering algorithm. It uses inputs from a wide variety of sensors to tune the autopilot's operation to provide superior control of the boat in any condition.
AutoLearn	Self-learning calibration feature available on S1G, S2G and S3G systems.
AWG	American Wire Gauge
CE	Marked on products that comply with defined European Community standards
CR pump	Constant Running hydraulic pump
EMC (Electromagnetic Compatibility)	When powered up, all electrical equipment produces electromagnetic fields. These can cause adjacent pieces of electrical equipment to interact with one another, and this can degrade their performance. By following the EMC guidelines in this handbook, you can minimize these effects by ensuring optimum Electromagnetic Compatibility (EMC) between equipment.
Fluxgate	Standard Raymarine compass supplied with core pack
GPS	Global Positioning System
GyroPlus	Raymarine's GyroPlus yaw sensor that measures the boat's rate of turn. It is built into the S1G, S2G and S3G systems.
Hz	Hertz (cycles per second)
I/O drive	Inboard/Outboard or stern drive
MARPA	Mini Automatic Radar Plotting Aid
NMEA	The NMEA (National Maritime Electronics Association) protocol is an internationally accepted serial communication interface standard for sharing data between electronic equipment. Raymarine products can share information with non-SeaTalk equipment using the NMEA 0183 protocol.
SeaTalk	SeaTalk is Raymarine's proprietary communication system. It links products to provide a single, integrated system sharing power and data.
SeaTalk bus	This refers to the continuous SeaTalk system connecting together a series of Raymarine units.
Yaw	Boat's rate of turn (°/sec)

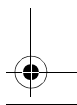
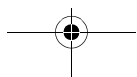
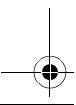
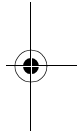
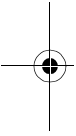
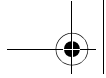

# Index

## A

- Alarms, 60
  - AUTO RELEASE, 60
  - CURRENT LIMIT, 60
  - DRIVE STOPPED, 61
  - LOW BATT, 61
  - LRN FAIL, 61
  - MOT POW SWAPPED, 61
  - NO DATA, 61
  - NO PILOT, 61
  - RG FAIL, 61
  - SEATALK/STLK FAIL, 62
- AutoLearn, 31
- AutoRelease
  - Alarm, 60
  - Calibration, 53
- AutoTrim, 50

## C

- Calibration
  - Non-G systems, 34
- Calibration groups, 39
- Commissioning, 19
  - AutoLearn, 31
  - Compass, 28
  - Dockside checks, 19
  - Heading alignment, 31
  - Seatrial, 27
- Compass calibration, 28
- Connecting optional components, 14
- Connections, 5
  - Compass, 8
  - Controller, 8
  - Drive unit, 5
  - Ground, 7
  - NMEA, 12
  - Optional components, 14
  - Power, 5
  - Rudder sensor, 8
  - SeaTalk equipment, 9
- Current limit alarm, 60

## D

- Data pages, 43
- Dealer Calibration, 45
  - Accessing, 45
  - Align rudder, 48
  - AutoAdapt, 55
  - AutoRelease, 53
  - AutoTack angle, 53
  - AutoTrim, 50
  - Counter rudder, 49
  - Cruise speed, 54
  - Defaults, 57
  - Drive type, 48
  - Gybe inhibit, 53
  - Joystick mode, 52
  - Latitude, 55
  - Off course warning angle, 52
  - Response level, 51
  - Rudder damping, 50
  - Rudder gain, 49
  - Rudder limit, 49
  - Seatrial calibration lock, 47
  - System reset, 56
  - Turn rate limit, 51
  - Vessel type, 47
  - Wind type, 54
  - WindTrim, 54
- Display calibration, 41
- Drive stopped alarm, 61

## E

- EMC
  - Installation guidelines, iii
  - Servicing and safety guidelines, 62

## F

- Fault finding, 59
- Fuse protection, 8

## G

- Glossary, 67
- GyroPlus fail alarm, 61

**H**

Help lines, 63

**J**

Joystick calibration, 52

**L**

Learn fail alarm, 61

Low battery alarm, 61

**M**

Maintenance, 62–63

Motor/Power swapped alarm, 61

**N**

NMEA

Inputs, 13

Outputs, 13

NMEA connections, 12

No data alarm, 61

No pilot alarm, 61

**P**

Performance, 34

Product support, 63

**R**

Removing the cover, 3

Replacing the cover, 3

Resetting the system, 56

Response level, 51

**S**

Safety notices, ii

SeaTalk connections, 9

Seatrial Calibration, 27

Service, 63

Settings, 39

Accessing calibration modes, 40

Advanced, 45

Align rudder, 48

AutoAdapt, 55

AutoRelease, 53

AutoTack angle, 53

AutoTrim, 50

Counter rudder, 49

Cruise speed, 54

Data pages, 43

Display calibration, 41

Drive type, 48

Gybe inhibit, 53

Heading selection, 42

Joystick, 52

Latitude, 55

Off course warning angle, 52

Pop-up pilot, 42

Response level, 51

Rudder Bar, 42

Rudder damping, 50

Rudder gain, 49

Rudder limit, 49

Seatrial calibration lock, 47

Turn rate limit, 51

Vessel type, 47

Wind type, 54

WindTrim, 54

SmartPilot computer, 2

Connections, 4

Swinging the compass, 28

System reset, 56

**T**

Technical support, 63

**U**

User Calibration, 44