

NAVIGATION LIGHTS

SERIES 41

USCG IMO BSH A-16 CE

Navigation Lights designed for direct mounting

Application

Designed for both powerboat and sailboat applications. Specific application depending on visibilities. See table in technical information.

Housing

Rigid polycarbonate black or white, shock resistant, non-corrosive, non-magnetic, seawater resistant.

Optics

Rigid acrylic fresnel lens, shock resistant, seawater resistant, easy to change; range of visibility 2 nm (Masthead 3 nm).

Equipment

IP 55 Navigation Lights; IP 67 Foredeck Lights

Electric

2 wire for navigation lights, 4 wire lead for combination unit. Spade connectors provided.

Certification Applicability

Aqua Signal navigation lights are certified as a complete assembly including the original equipment bulb to maintain ongoing certification.





Protection

IP 56

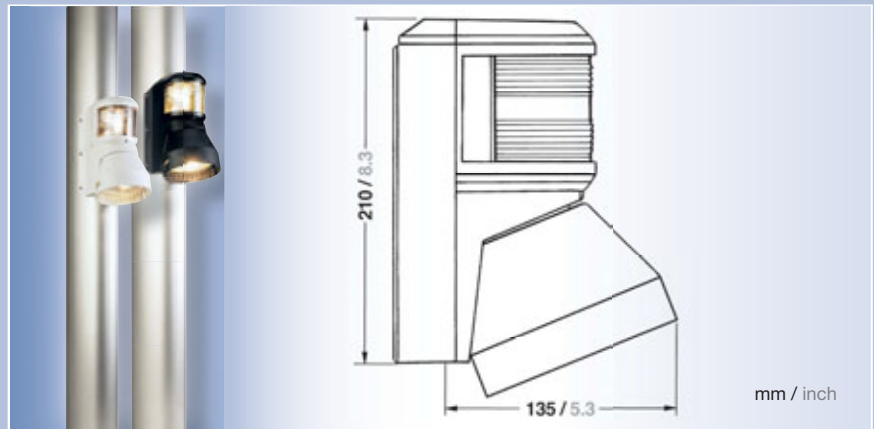
Mounting

Side-mount



Including illuminant								
Article number		Description	Vessels	Wattage	Visibility	Housing color	Voltage	Item weight
41404		masthead / foredeck comb.	< 20 m / < 65 ft	25 W (masthead); 50 W (foredeck)	3 nm	black	12 V	720 g
41405		masthead / foredeck comb.	< 20 m / < 65 ft	25 W (masthead); 50 W (foredeck)	3 nm	white	12 V	720 g
41424		masthead / foredeck comb.	< 20 m / < 65 ft	25 W (masthead); 50 W (foredeck)	3 nm	black	24 V	720 g
41425		masthead / foredeck comb.	< 20 m / < 65 ft	25 W (masthead); 50 W (foredeck)	3 nm	white	24 V	720 g





SERIES 41





Including illuminant								
Article number		Description	Vessels	Wattage	Visibility	Housing color	Voltage	Item weight
41200		starboard	< 20 m / < 65 ft	25 W	2 nm	black	12 V	270 g
41201		starboard	< 20 m / < 65 ft	25 W	2 nm	white	12 V	270 g
41220		starboard	< 20 m / < 65 ft	25 W	2 nm	black	24 V	270 g
41221		starboard	< 20 m / < 65 ft	25 W	2 nm	white	24 V	270 g
41300		port	< 20 m / < 65 ft	25 W	2 nm	black	12 V	270 g
41301		port	< 20 m / < 65 ft	25 W	2 nm	white	12 V	270 g
41320		port	< 20 m / < 65 ft	25 W	2 nm	black	24 V	270 g
41321		port	< 20 m / < 65 ft	25 W	2 nm	white	24 V	270 g
41100		bicolor	< 20 m / < 65 ft	25 W	2 nm	black	12 V	270 g
41101		bicolor	< 20 m / < 65 ft	25 W	2 nm	white	12 V	270 g
41120		bicolor	< 20 m / < 65 ft	25 W	2 nm	black	24 V	270 g
41121		bicolor	< 20 m / < 65 ft	25 W	2 nm	white	24 V	270 g
41400		masthead	< 20 m / < 65 ft	25 W	3 nm	black	12 V	270 g
41401		masthead	< 20 m / < 65 ft	25 W	3 nm	white	12 V	270 g
41420		masthead	< 20 m / < 65 ft	25 W	3 nm	black	24 V	270 g
41421		masthead	< 20 m / < 65 ft	25 W	3 nm	white	24 V	270 g
41500		stern	< 20 m / < 65 ft	10 W	2 nm	black	12 V	270 g
41501		stern	< 20 m / < 65 ft	10 W	2 nm	white	12 V	270 g
41520		stern	< 20 m / < 65 ft	10 W	2 nm	black	24 V	270 g
41521		stern	< 20 m / < 65 ft	10 W	2 nm	white	24 V	270 g
41502		stern yellow	< 20 m / < 65 ft	10 W	2 nm	black	12 V	270 g
3541403		stern yellow	< 20 m / < 65 ft	10 W	2 nm	black	24 V	270 g



NAVIGATION LIGHTS

SERIES 41

Spare Parts /*Extras

- 41210 
- 41310 
- 41110 
- 41410 
- 23541004 

- 41222 
- 41322 
- 41422 
- 41522 
- 23542001 

- 23543006 
- 23544006 
- 23540015 
- 23541008 
- 23542007 

- 23540005 
- 90002 12V/25W
- 90003 24V/25W
- 90005 12V/10W
- 90006 24V/10W

23540011

41150

- GE P/N 4406 12V/35W
- GE P/N H7606 12V/50W Halogen
- GE P/N 4593 24V/50W

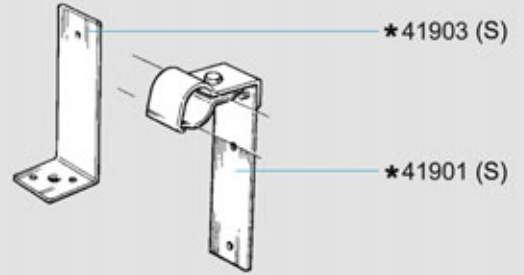

*41903 (S)

*41901 (S)

23540008

*41902 (S)

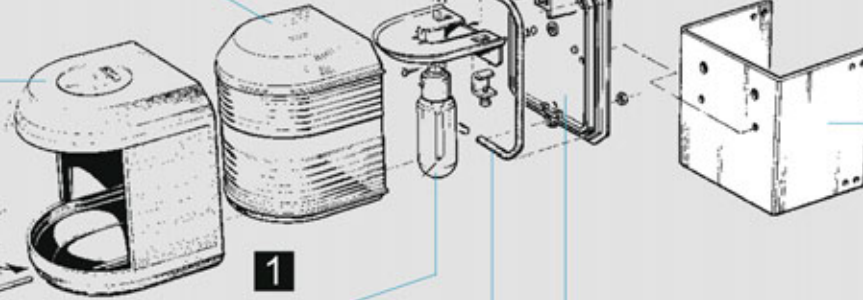

1

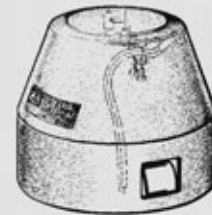

2

